



BD8-12KTR-RH3 User Manual

Energy Storage Inverter



INVT Solar Technology (Shenzhen) Co., Ltd.

contents

1	Notes on this Manual	1
1.1	Scope of Validity.....	1
1.2	Target Group.....	1
1.3	Symbols Used	1
2	Safety	2
2.1	Important Safety Instructions.....	2
2.2	Notes on this Manual Explanation of Symbol	6
2.3	CE Directives	7
3	Introduction	8
3.1	Basic features	8
3.2	Work Modes	10
3.3	Dimension.....	11
3.4	Terminals of PV inverter	12
4.	Technical Data.....	13
4.1	Battery interface parameters (apply to version E,I)	13
4.2	Photovoltaic interface parameters (apply to version E, I).....	13
4.3	Ac side grid connection parameters (apply to version E, I).....	13
4.4	Ac side off-grid parameters (apply to version E, I).....	14
4.5	mechanical parameter(apply to version E, I).....	14
4.6	IGMP Interface Parameters (apply to version E, I).....	14
4.7	basic parameter (apply to version E, I).....	16
4.8	protect function (apply to version E, I).....	16
5.	Installation	17
5.1	Check for Physical Damage	17
5.2	Packing List.....	17
5.3	Mounting	18
6.	Electrical Connection.....	21
6.1	PV connection	21
6.2	Grid Connection	23
6.3	EPS Connection(apply to I Version and E Version only).....	25
6.4	Battery Connection.....	28
6.5	Meter Connection	30
6.6	DRM Connection	32
6.7	WiFi Connection(optional).....	34
6.8	GPRS Connection(optional)	35
6.9	Inverter Manipulation.....	36
7.	Setting.....	38
7.1	Control Panel.....	38
7.2	Instructions for LED Indicator	39
7.3	Instructions for the use of three modes	39
8.	LCD Operation	42
8.1	LCD Interface	42

8.2	Setting	46
9.	Fault diagnosis and solutions.....	60

1 Notes on this Manual

1.1 Scope of Validity

This manual is an integral part of BD Hybrid , It describes the assembly, installation, commissioning, maintenance and failure of the product. Please read it carefully before operating.

BD8KTR-RH3	BD10KTR-RH3	BD12KTR-RH3
------------	-------------	-------------

Naming rules, For example: BD10KTR-RH3

“10K” means “output power 10kw ”.

“L” means “Low Battery Voltage”. “H” means over “High Battery Voltage”.

“1、 3” means “Output single-phase (1) or three-phase (3).”





Store this manual where it will be accessible at all times.

1.2 Target Group

This manual is for qualified electricians. The tasks described in this manual only can be performed by qualified electricians.

1.3 Symbols Used

The following types of safety instructions and general information appear in this document as described below:

	<p>Danger !</p> <p>“Danger” indicates a hazardous situation which, if not avoided, will result in death or serious injury.</p>
	<p>Warning!</p> <p>“Warning” indicates a hazardous situation which, if not avoided, could result in death or serious injury.</p>
	<p>Caution !</p> <p>“Caution” indicates a hazardous situation which, if not avoided, could result in minor or moderate injury.</p>
	<p>Note !</p> <p>“Note” provides tips that are valuable for the optimal operation of our product</p>

2 Safety

2.1 Important Safety Instructions

 **Danger!**
Danger to life due to high voltages in the inverter! All work must be carried out by qualified electrician.
The appliance is not to be used by children or persons with reduced physical sensory or mental capabilities, or lack of experience and knowledge, unless they have been given supervision or instruction.

 **Caution!**
Danger of burn injuries due to hot enclosure parts!
During operation, the upper lid of the enclosure and the enclosure body may become hot.

 **Caution!**
Possible damage to health as a result of the **effects** of radiation!
Do not stay closer than 20 cm to inverter for any length of time.

 **Note!**
Grounding the PV generator.
Comply with the local requirements for grounding the PV modules and the PV generator. It is recommended connecting the generator frame and other electrically conductive surfaces in a manner which ensures continuous **conduction and ground** these in order to have optimal protection of system and persons.

 **Warning!**
Ensure input DC voltage \leq Max. DC voltage .Over voltage may cause permanent damage to inverter or other losses, which will not be included in warranty!

 **Warning!**
Authorized service personnel must disconnect both AC and DC power from inverter before attempting any maintenance or cleaning or working on any circuits connected to inverter.

 **WARNING !**
Do not operate the inverter when the device is running.

 **WARNING !**
Risk of electric shock!

- Prior to the application, please read this section carefully to ensure correct and safe application. Please keep the user manual properly.
- Accessories only together with the inverter shipment are recommended here. Otherwise may result in a risk of fire, electric shock, or injury to person.
- Make sure that existing wiring is in good condition and that wire is not undersized.
- Do not disassemble any parts of inverter which are not mentioned in installation guide. It contains no user-serviceable parts. See Warranty for instructions on obtaining service. Attempting to service the inverter yourself may result in a risk of electric shock or fire and will void your warranty.
- Keep away from flammable, explosive materials to avoid fire disaster.
- The installation place should be away from humid or corrosive substance.
- Authorized service personnel must use insulated tools when installing or working with this equipment.
- PV modules shall have an IEC 61730 class A rating.
- Never touch either the positive or negative pole of PV connecting device. Strictly prohibit touching both of them at the same time.
- The unit contains capacitors that remain charged to a potentially lethal voltage after the MAINS, battery and PV supply has been disconnected.
- Hazardous voltage will present for up to 5 minutes after disconnection from power supply.
- CAUTION-RISK of electric shock from energy stored in capacitor, Never operate on the inverter couplers, the MAINS cables, Battery cables, PV cables or the PV generator when power is applied. After switching off the PV, battery and Mains, always wait for 5 minutes to let the intermediate circuit capacitors discharge before unplugging DC, battery inplug and MAINS couplers.
- When accessing the internal circuit of inverter, it is very important to wait 5 minutes before operating the power circuit or demounting the electrolyte capacitors inside the device. Do not open the device before hand since the capacitors require time sufficiently discharge!
- Measure the voltage between terminals UDC+ and UDC- with a multi-meter (impedance at least 1Mohm) to ensure that the device is discharged before beginning work (35VDC) inside the device.

Surge protection devices (SPDs) for PV installation

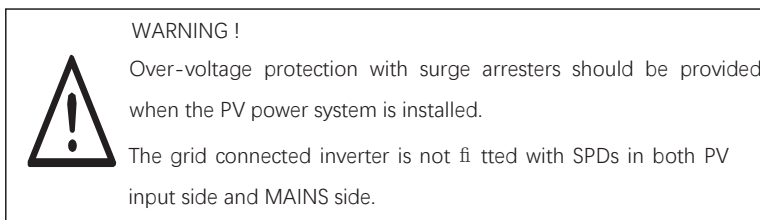

Lightning will cause a damage either from a direct strike or from surges due to a nearby strike.

Induced surges are the most likely cause of lightning damage in majority of installations, especially in rural areas where electricity is usually provided by long overhead lines.

Surge may be included on both the PV array conduction and the AC cables leading to the building.

Specialists in lightning protection should be consulted during the end use application. Using appropriate external lightning protection, the effect of a direct lightning strike into a building can be mitigated in a controlled way, and the lightning current can be discharged into the ground.

Installation of SPDs to protect the inverter against mechanical damage and excessive stress include a surge arrester in case of a building with external lightning protection system (LPS) when separation distance is kept.

To protect the DC system, surge suppression device (SPD type2) should be fitted at the inverter end of the DC cabling and at the array located between the inverter and the PV generator, if the voltage protection level (VP) of the surge arresters is greater than 1100V, an additional SPD type 3 required for surge protection for electrical devices.

To protect the AC system, surge suppression devices (SPD type2) should be fitted at the main incoming point of AC supply (at the consumer's cutout), located between the inverter and the meter/distribution system; SPD (test impulse D1) for signal line according I to EN 61632-1.

All DC cables should be installed to provide as short a run as possible, and positive and negative cables of the string or main DC supply should be bundled together.

Avoiding the creation of loops in the system.

Spark gap devices are not suitable to be used in DC circuits once conducting, they won't stop conducting until the voltage across their terminals is typically more than 30 volts.

Anti-Islanding Effect

Islanding effect is a special phenomenon that grid-connected PV system still supply power to the nearby grid when the voltage loss is happened in the power system. It is dangerous for maintenance personnel and the public.

BD series hybrid inverter provide Active Frequency Drift (AFD) to prevent islanding effect.

PE Connection and Leakage Current

- The end-use application shall monitor the protective conductor by residual current operated protective device (RCD) with rated fault current $I_{fn} \leq 240\text{mA}$ which automatically disconnects the device in case of a fault.

The device is intended to connect to a PV generator with a capacitance limit of approx 700nf.

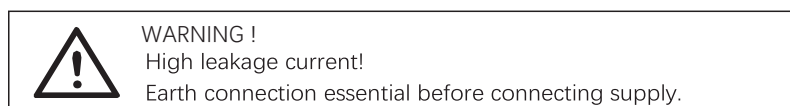

- Incorrect grounding can cause physical injury, death or equipment malfunction and increase electromagnetic.
- Make sure that grounding conductor is adequately sized as required by safety regulations.
- Do not connect the ground terminals of the unit in series in case of a multiple

installation. This product can cause current with a d.c component, Where a residual current operated protective (RCD) or monitoring (RCM) device is used for protection in case of direct or indirect contact, only an RCD or RCM of type B is allowed on the supply side of this product.

For United Kingdom

- The installation that connects the equipment to the supply terminals shall comply with the requirements of BS 7671.
- Electrical installation of PV system shall comply with requirements of BS 7671 and IEC 60364-7-712.
- No protection settings can be altered.
- User shall ensure that equipment is so installed, designed and operated to maintain at all times compliance with the requirements of ESQCR22(1)(a).

For Australia and New Zealand

- Electrical installation and maintenance shall be conducted by licensed electrician and shall comply with Australia National Wiring Rules.

Battery Safety Instructions

BD series hybrid inverter should be worked with high voltage battery, for the specific parameters such as battery type, nominal voltage and nominal capacity etc., please refer to section 4.3.











As accumulator batteries may contain potential electric shock and short-circuit current danger, to avoid accidents that might be thus resulted, the following warnings should be observed during battery replacement:

- 1: Do not wear watches, rings or similar metallic items.
- 2: Use insulated tools.
- 3: Put on rubber shoes and gloves.
- 4: Do not place metallic tools and similar metallic parts on the batteries.
- 5: Switch off load connected to the batteries before dismantling battery connection terminals.
- 6: Only personal with proper expertise can carry out the maintenance of accumulator batteries.

2.2 Notes on this Manual Explanation of Symbol

This section gives an explanation of all the symbols shown on the inverter and on the type label.

Symbols on the Type Label

Symbol	Explanation
	CE mark. The inverter complies with the requirements of the applicable CE guidelines.
	TUV certified.
	RCM remark.
	SAA certification.
	Beware of hot surface. The inverter can become hot during operation. Avoid contact during operation.
	Danger of high voltages. Danger to life due to high voltages in the inverter!
	Danger. Risk of electric shock!
	Observe enclosed documentation
	The inverter can not be disposed together with the household waste. Disposal information can be found in the enclosed documentation.
	Do not operate this inverter until it is isolated from battery, mains and on-site PV generation suppliers.
	Danger to life due to high voltage. There is residual voltage existing in the inverter after powering off, which needs 5 min to discharge. • Wait 5 min before you open the upper lid or the DC lid.

2.3 CE Directives

This chapter follows the requirements of the European low voltage directives, which contains the safety instructions and conditions of acceptability for the end user system, which you must follow when installing, operating and servicing the unit. If ignored, physical injury or death may follow, or damage may occur to the unit. Read this before you work on the unit. If you are unable to understand the dangers, warnings, cautions or instructions, please contact an authorized service dealer before installing. Operating and servicing the unit.

The Grid connected inverter meets the requirement stipulated in Low Voltage Directive (LVD) 2014/35/EU and Electromagnetic Compatibility (EMC) Directive 2014/30/EU. The unit is based on: EN 62109-1:2010; EN 62109-2:2011; IEC 62109-1(ed.1) ; IEC 62109-2(ed.1); EN 61000-6-3:2007+A:2011; EN 61000-6-1:2007; EN 61000-6-2:2005;

In case of installation in PV system, startup of the unit (i.e. start of designated operation) is prohibited until it is determined that the full system meets the requirements stipulated in EC Directive (2014/35/EU, 2014/30/EU, etc.), The grid connected inverter leave the factory completely connecting device and ready for connection to the mains and PV supply, the unit shall be installed in accordance with national wiring regulations. Compliance with safety regulations depends upon installing and configuring system correctly, including using the specified wires.

The system must be installed only by professional assemblers who are familiar with requirements for safety and EMC. The assembler is responsible for ensuring that the end system complies with all the relevant laws in the country where it is to be used.

The individual subassembly of the system shall be interconnected by means of the wiring methods outlined in national/inter national such as the national electric code (NFPA) No.70 or VDE regulation 0107.

3 Introduction

3.1 Basic features

BD series is a high-quality inverter which can convert solar energy to AC energy and store energy into battery.

The inverter can be used to optimize self-consumption, store in the battery for future use or feed in to public grid. Work mode depends on PV energy and user's preference. It can provide power for emergency use during the grid lost by using the energy from battery and inverter generated from PV.

System Diagram

BD series is designed with two EPS versions for customer to choose based on the local rules.

E Version applies to the wiring rules that requires the Live line and Neutral line of EPS must be disconnected with the Live line and Neutral line of grid (applies to most countries).

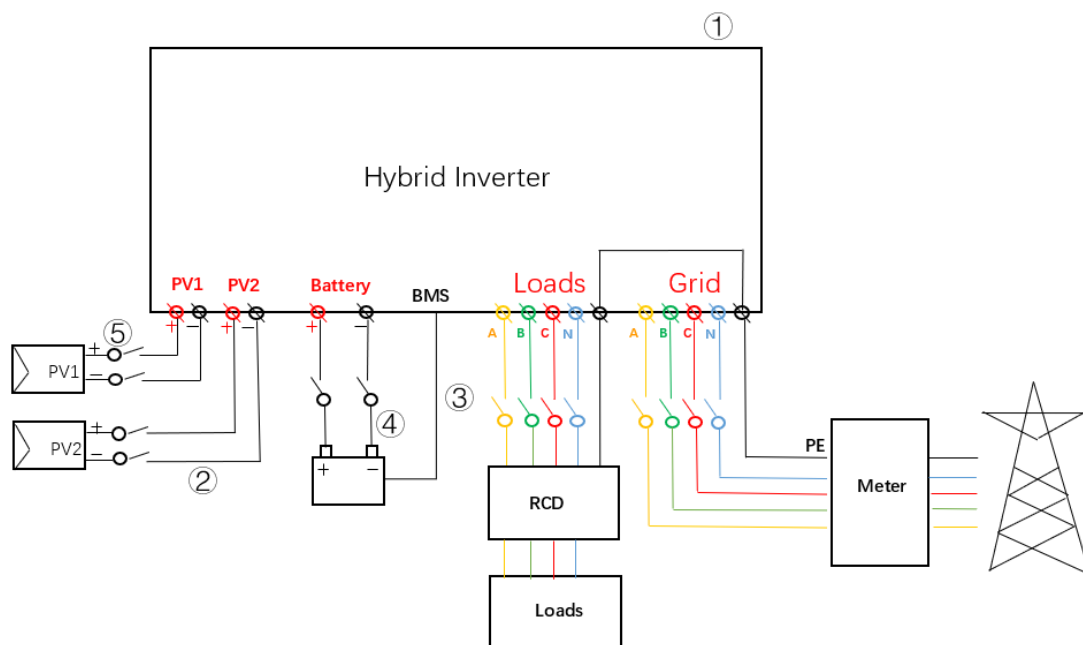

I Version applies to the wiring rules that requires Neutral line of alternative supply must NOT be isolated or switched (applies to wiring rules AS/NZS_3000:2012 for Australia and New Zealand).

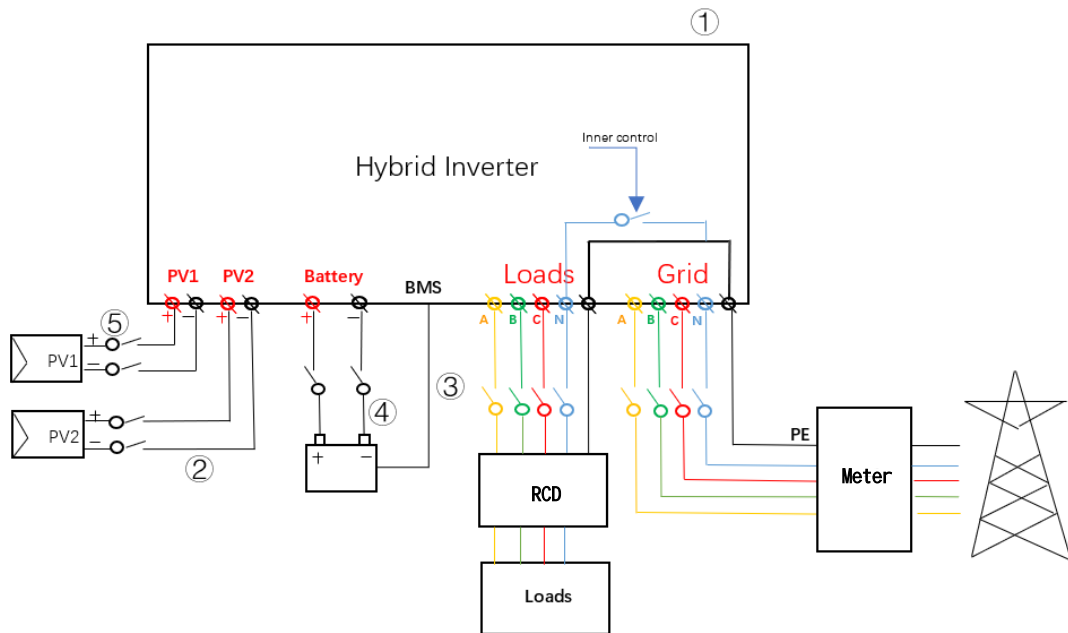

Note!



- Please control the home loads, and make sure it's within the "EPS output rating" under EPS mode, otherwise the inverter will shutdown with an "overload fault" warning.
- Please confirm with the mains grid operator whether there is any special regulations for grid connection.

3.2 Work Modes

Hybrid Series inverter provides multiple work modes based on different requirements.

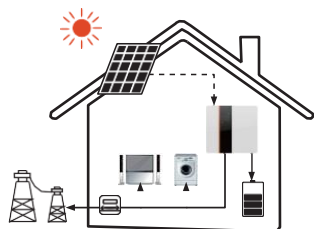

Work modes: **Self-use** (with PV Power)

Priority: load>battery>grid

This mode applies the area that has low feed-in tariff and high energy price.

The power generated from PV will be used to supply the local loads firstly, then to charge the battery. The redundant power will export to the public grid.

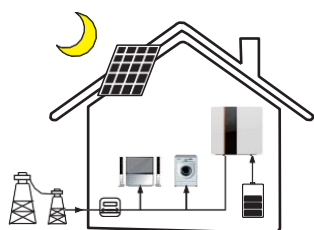

Work modes: **Self-use** (without PV Power)

When no PV supplied, battery will discharge for local loads firstly, and grid will supply power when the battery capacity is not enough.

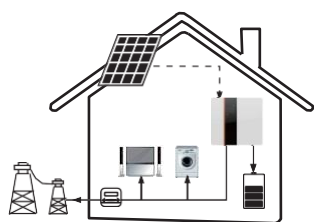

Work modes: **Force time use**

Priority: battery>load>grid (when charging)

Priority: load>battery>grid (when discharging) This mode applies the area that has electricity price between peak and valley. User can use off-peak electricity to charge the battery

The charging and discharging time can be set flexibly, and it also allows to choose whether charge from the grid or not.

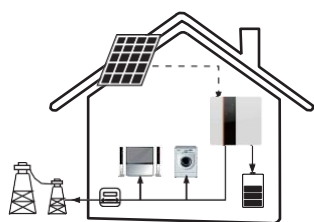

Work modes: **Feed in Priority**

Priority: load>grid>battery

This mode applies the area that has high feed-in tariff and export control.

The PV generated power will be used to supply the local loads firstly, then export to the public grid. The redundant power will charge the battery.

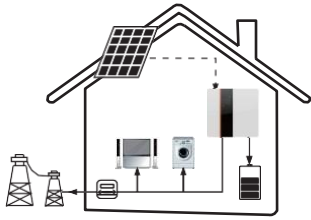

Work modes: **Back up mode**

Priority: battery>load>grid

This mode applies the area that has frequent power outages. And this mode ensures the battery will have enough energy to supply when the grid is off.

In this mode battery will be charging forcibly in the setting time and will never be discharged when the grid is on, and it also allows to choose whether charge from the grid or not.

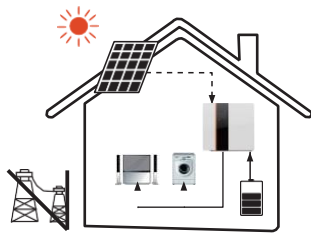

EPS Status

When the grid is off, system will supply emergency power from PV or battery to supply the home loads. (Battery is necessary in EPS mode).

3.3 Dimension

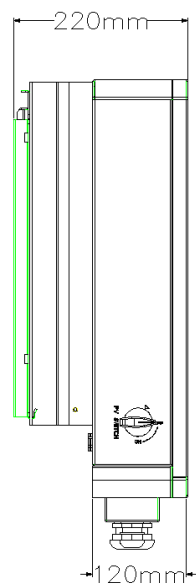
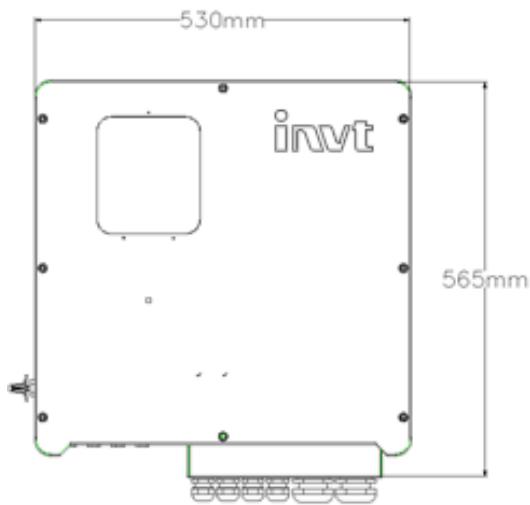

3.4 Terminals of PV inverter

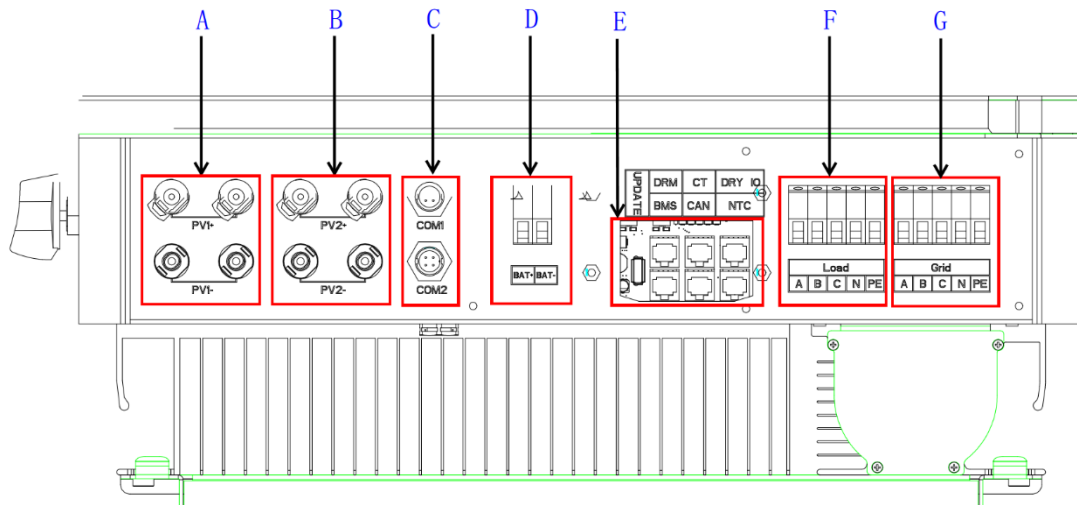

Object	Description
A	PV1+, PV1-
B	PV2+, PV2-
C	COM1: WIFI COM2: Reserved port
D	BAT+ : battery+, BAT- : battery+
E	BMS: battery manage system communication DRM: demand respond mode Dry IO: dry contact for peripheral CAN: upper computer communication (EMS) NTC: Reserved temperature sensor CT: Power meter
F	EPS out
G	Grid out



WARNING !

Qualified electrician will be required for the installation.

4. Technical Data

4.1 Battery interface parameters (apply to version E,I)

MODEL	BD8KTR-RH3	BD10KTR-RH3	BD12KTR-RH3
Battery voltage range (V)	125~600		
Maximum battery current (A)	50		
Maximum charge and discharge power (W)	8800	11000	13200

4.2 Photovoltaic interface parameters (apply to version E, I)

MODEL	BD8KTR-RH3	BD10KTR-RH3	BD12KTR-RH3
Maximum DC voltage (V)	1000		
MPPT voltage range (V)	125~850		
Starting voltage (V)	125		
Maximum input current (A)	13/13	13/13	13/13
Maximum DC input power (W)	1140	13000	15600
Maximum short circuit current	15	15	15
MPPT tracker	2	2	2
Strings of per MPPT tracker	1/1	1/1	1/1

4.3 Ac side on-grid parameters (apply to version E, I)

MODEL	BD8KTR-RH3	BD10KTR-RH3	BD12KTR-RH3
AC output power (VA)	8000	10000	12000
Maximum Input power (VA)	8800	11000	13200

maximum output current (A)	12.7	15.8	19
Max input Current (A)	12.7	15.8	19
Rated Output Voltage (V)	400V, 3W+N+PE		
rated frequency (Hz)	50Hz/60Hz		
Current harmonic distortion (@ rated power)	<3%		
power factor	1 (-0.8~+0.8)		

4.4 Ac side off-grid parameters (apply to version E, I)

MODEL	BD8KTR-RH3	BD10KTR-RH3	BD12KTR-RH3
Rated output power (VA)	8000	10000	12000
Rated Output Voltage (V)	400V, 3W+N+PE		
Rated frequency (Hz)	50Hz/60Hz		
THDI (@ rated power)	<3%		
Maximum efficiency	97.9%	98.2%	98.2%
European efficiency	97.2%	97.5%	97.5%
MPPT efficiency	99.5%	99.5%	99.5%
Battery charging and discharging efficiency	97.5%	97.5%	97.6%

4.5 Mechanical parameter (apply to version E, I)

MODEL	BD8KTR-RH3	BD10KTR-RH3	BD12KTR-RH3
Dimension(W/H/D)(mm)	520*550*180	520*550*180	520*550*180
Weight(kg)	23	24	25

4.6 IGMP Interface Parameters (apply to version E, I)

MODEL	BD8KTR-RH3	BD10KTR-RH3	BD12KTR-RH3
HMI	LED; APP		

Technical Data

BMS	RS485, CAN
EMS	RS485
POWER METER	RS485
OTHERS communication	WIFI or WAN

4.7 Basic parameter (apply to version E, I)

Version	BD8KTR-RH3	BD10KTR-RH3	BD12KTR-RH3
Ingress Protection	IP65		
Operating temperature range	-25~60°C (derating at 45°C)		
Relative humidity	0~100%		
Altitude	derating >2000m		
Cooling mode	Natural		
Noise Level	≤30dB		
Installation	Wall-mounted		

4.8 Safety & Protection (apply to version E, I)

Version	BD8KTR-RH3	BD10KTR-RH3	BD12KTR-RH3
Anti-islanding protection	yes		
Photovoltaic input connection reverse protection	yes		
Battery input connection reverse protection	yes		
Insulation monitor	yes		
Residual current detection	yes		
PV Input overvoltage over power	yes		
The battery input overvoltage overpower protection	yes		
Ac output input overvoltage overpower	yes		
over-temperature protection	yes		
ripple current over limit	yes		
Reference power failure protection	yes		

5. Installation

5.1 Check for Physical Damage

Make sure the inverter is intact during transportation. If there is any visible damage, such as cracks, please contact your dealer immediately.

5.2 Packing List

Open the package and take out the product, please check the accessories first. The packing list shown as below.

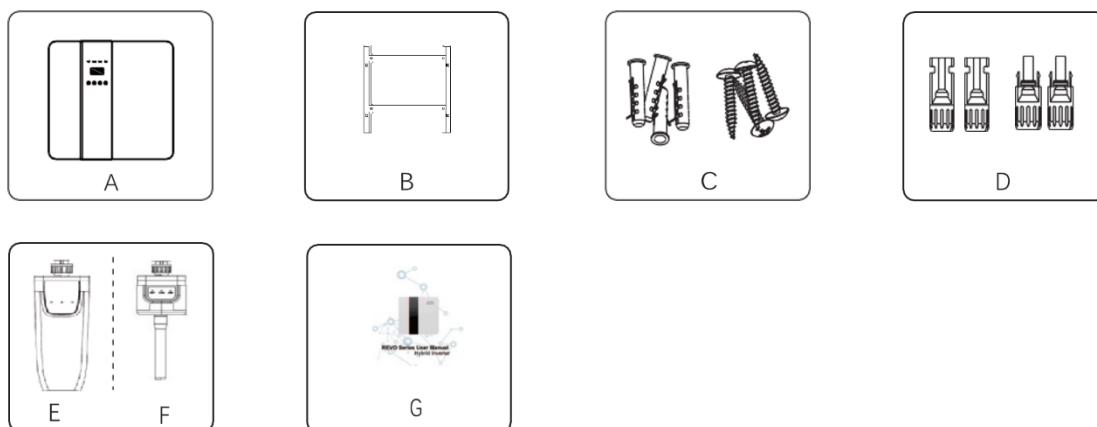

Object	Description
A	Inverter
B	Bracket
C	Expansion screws and pan-head screws
D	PV connectors (2*positive, 2*negative)
E	WIFI module (optional)
F	GPRS module (optional)
G	User manual

5.3 Mounting

Installation Precaution

BD series hybrid inverter is designed for outdoor installation (IP 65). Make sure the installation site meets the following conditions:

- Not in direct sunlight.
- Not in areas where highly flammable materials are stored.
- Not in potential explosive areas.
- Not in the cool air directly.
- Not near the television antenna or antenna cable.
- Not higher than altitude of about 2000m above sea level.
- Not in environment of precipitation or humidity (> 95%).
- Under good ventilation condition.
- The ambient temperature in the range of -20C° to $+60\text{C}^{\circ}$.
- The slope of the wall should be within $\pm 5^{\circ}$.
- The wall hanging the inverter should meet conditions below:
 1. solid brick/concrete, or strength equivalent mounting surface;
 2. Inverter must be supported or strengthened if the wall's strength isn't enough (such as wooden wall, the wall covered by thick layer of decoration)

Please AVOIDE direct sunlight, rain exposure, snow laying up during installation and operation.

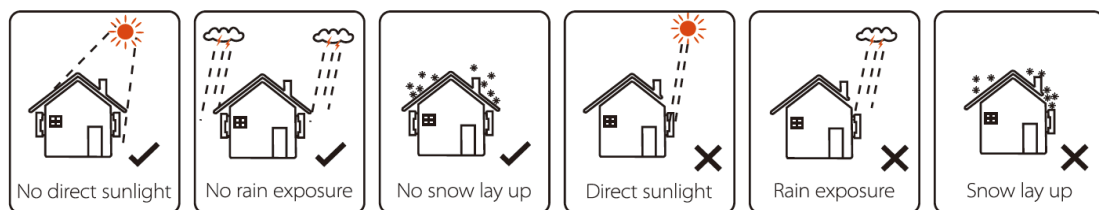

Space Requirement

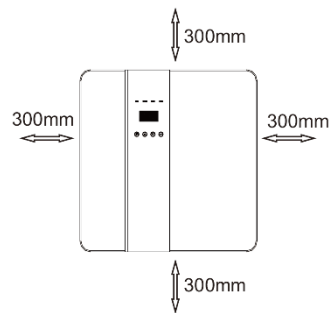

Position	Minsize
Left	300mm
Right	300mm
Top	300mm
Bottom	300mm
Front	300mm

Mounting Steps

Tools required for installation.

Installation tools : crimping pliers for binding post and RJ 45, screwdriver, manual wrench etc



Step 1: Screw the wall bracket on the wall

- 1.1 Place the bracket on the wall and mark down the position of the 4 holes.
- 1.2 Drill holes with driller, make sure the holes are deep enough (at least 60mm) to support the inverter.
- 1.3 Install the expansion tubes in the holes, and tighten them. Then install the wall bracket with the expansion screws.

Step 2: Place the inverter on the wall mounted bracket by holding the handle on the side.

Step 3: Tighten the fixing screws on both sides of the inverter.

Step 4: If necessary, customer can install an anti-theft lock on the left-bottom of the inverter.

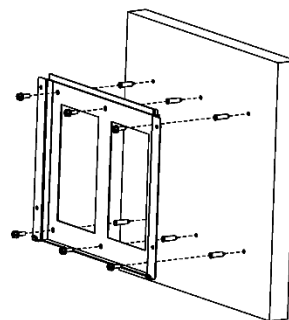
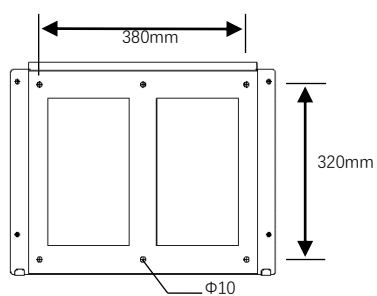

Step1

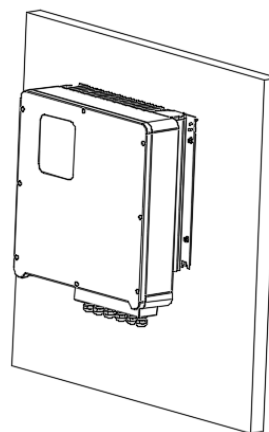
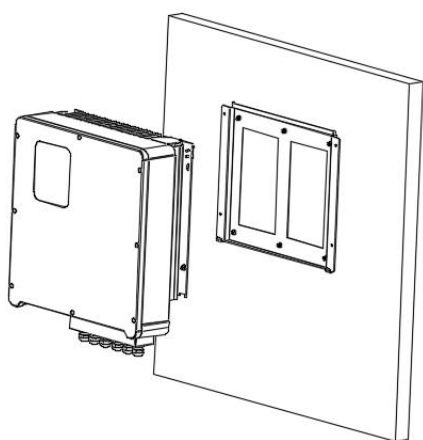

Step2

6. Electrical Connection

6.1 PV connection

BD series hybrid inverter can be connected in series with 2-strings PV modules for 8KW, 10KW and 12KW. Select PV modules with excellent function and reliable quality. Open-circuit voltage of module arrays connected in series should be <Max. DC input voltage; operating voltage should be conformed to MPPT voltage range.

Max.DC Voltage Limitation

Model	BD8KTR-RH3	BD10KTR-RH3	BD12KTR-RH3
Max. DC Voltage (V)	1000		
MPPT Voltage Range (V)	125~850		



Warning!

- PV module voltage is very high, which already achieve dangerous voltage range, please comply with electric safety rules when connecting.
- Please do not make PV positive or negative ground!



Note!

- The following requirements of PV modules need to be applied for each input area;
- Please do not make PV positive or negative ground!
- In order to save cable and reduce the DC loss, we suggest to install the inverter near PV modules.



Note!
PV connection mode below is NOT allowed!

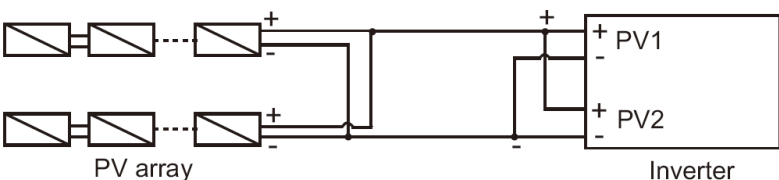

PV array Inverter

Connection Steps:

Step1. Checking PV module.

- 1.1 Use multimeter to measure module array voltage.
- 1.2 Check the PV+ and PV- from the PV string combiner box correctly.
- 1.3 Please make sure the impedance between the positive pole and negative pole of PV to earth should be MΩ level.

Step2. Separating the DC connector.

Step3. Wiring.

- 3.1 Choose the 12 AWG wire to connect with the cold-pressed terminal.
- 3.2 Remove 10mm of insulation from the end of wire.
- 3.3 Insert the insulation into pin contact and use crimping plier to clamp it.

Step4. Insert pin contact through the cable nut to assemble into back of the male or female plug. When you feel or heard a “click” sound the pin contact assembly is seated correctly.

Step5. Plug the PV connector into the corresponding PV connector on inverter

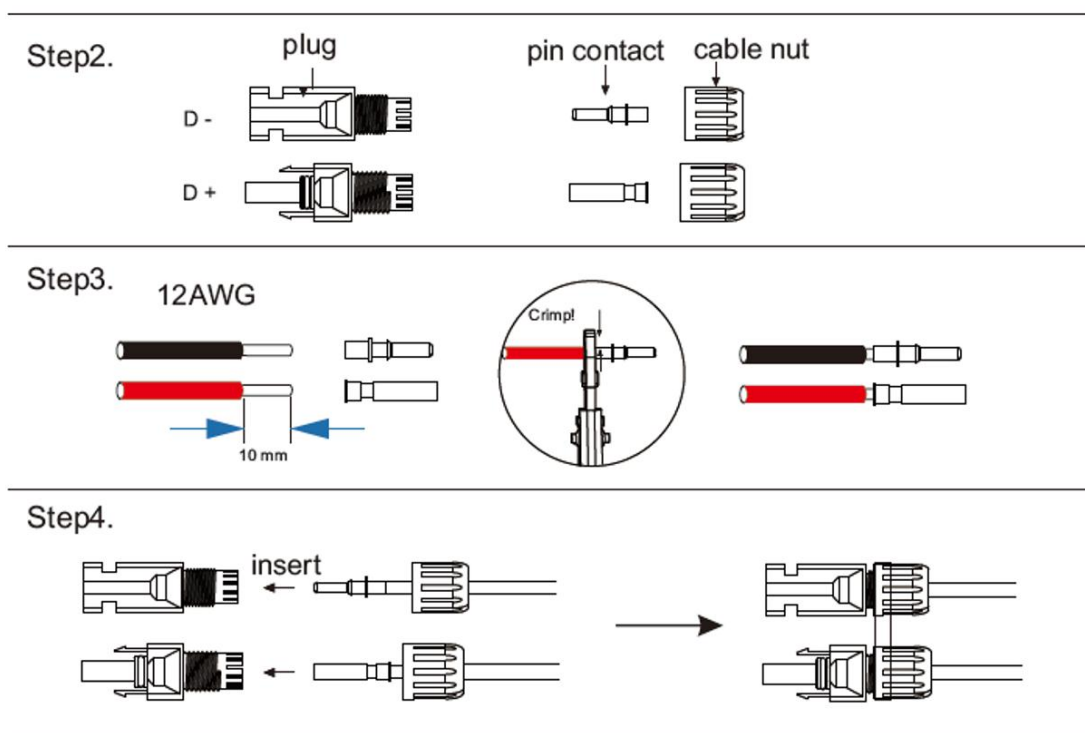

6.2 Grid Connection

BD series hybrid inverter are designed for single phase grid. Voltage is 220/230/240V, frequency is 50/60Hz. Other technical requests should comply with the requirement of the local public grid.

Table 4 Cable and Micro-breaker recommended

Model	BD8KTR-RH3	BD10KTR-RH3	BD12KTR-RH3
E Version			
Cable	4-5 mm ²		5-6 mm ²
Micro-breaker	20A	32A	40A
I Version			
Cable	6-8mm ²		12-16mm ²
Micro-breaker	40A		63A

Micro-breaker should be installed between inverter and grid, any load should not be connected with inverter directly.

Connection Steps:

Step1. Check the grid voltage.

1.1 Check the grid voltage and compare with the permissive voltage range (Please refer to technical data).

1.2 Disconnect the circuit board from all the phases and secure against re-connection.

Step2. Remove the waterproof lid from the grid port on the inverter.

Step3. Make AC wires.

3.1 Choose the appropriate wire (Cable size: refer to Table 4).

3.2 Reserve about 60mm of conductor material sectional area.

3.3 Remove 10mm of insulation from the end of wire.

Step4. Connect the AC connector to the GRID port of the inverter with a slotted screwdriver

Step2

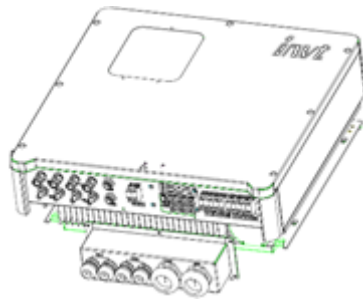

Step3

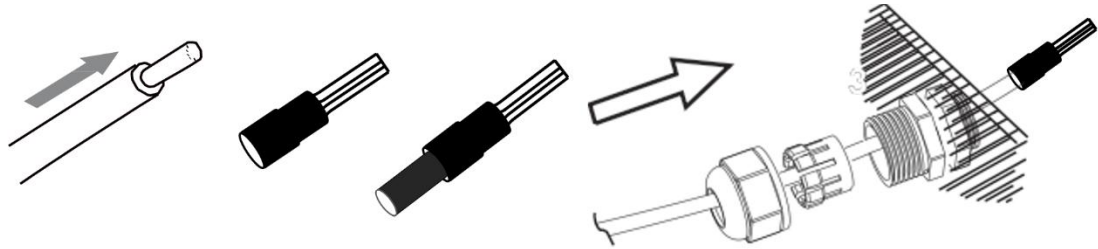

Step4

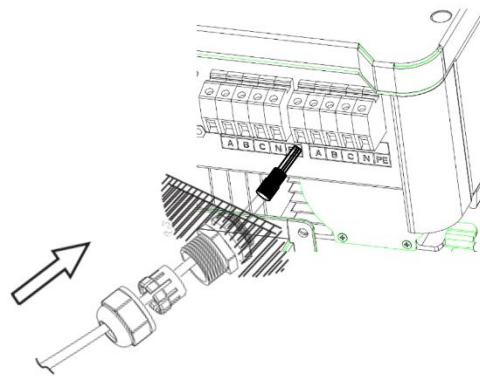

6.3 EPS Connection (apply to I Version and E Version only)

BD series hybrid inverter has On and Off grid function, the inverter will deliver output power through AC port when the grid is on, and it will deliver output power through EPS port when the grid is off.

I Version & E Version

BD series hybrid inverter provides two versions for customer to choose based on the local rules.

“I Version” means inverter has an build-in changeover switch. This version applies to the wiring rules which requires Neutral line of alternative supply must not be isolated or switched. (applies to wiring rules AS/NZS3000:2014 of Australia and New Zealand.)

“E Version” means inverter needs to install an external changeover device for EPS. function. This version applies to the wiring rules which allows Neutral line of alternative supply can be isolated or switched. (applies to most of the countries).

Auto & Manual

EPS function can be achieved automatically or manually according to user's wishes. For “I Version” inverter, EPS function can only be triggered automatically.

For “E Version” inverter, EPS function can be triggered either automatically or manually according to user's preference.

If user wants to use this function manually, it will need to be installed an external switch.

Please refer to specific wiring diagram below.

For automagical solution, please contact our sales.

I Version Auto Do not require for Changeover Switch

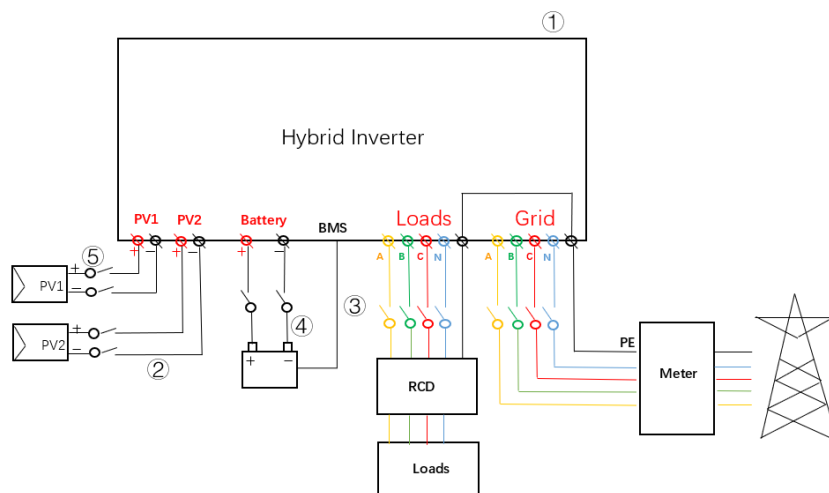

E VersionAuto Required for Changeover Switch

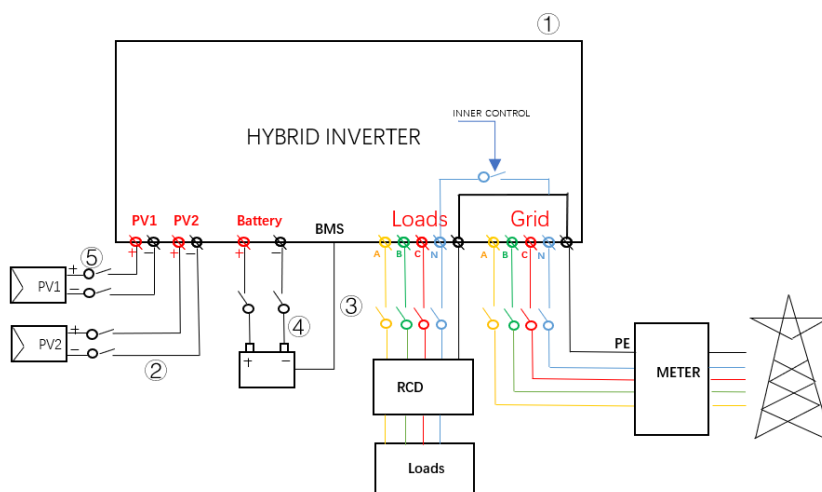

Please contact our sales for any compatible contactor purchase requirement

Note!
 In case of discrepancies between wiring mode of local policy and the operation guide above, especially for the wiring of neutral line,

Connection Steps:

Step1. Make EPS wires

- 3.1 Choose the appropriate wire (cable size: refer to picture below).
- 3.2 Reserve about 60mm of conductor material sectional area.
- 3.3 Remove 10mm of insulation from the end of wire.

Step2. Connect the AC connector to the EPS port of the inverter with a slotted screwdriver

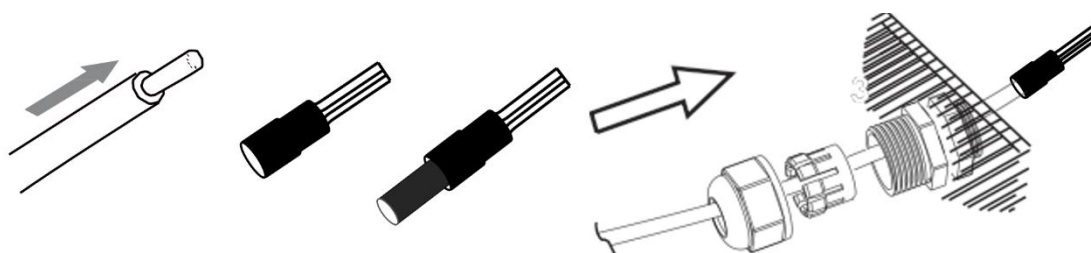
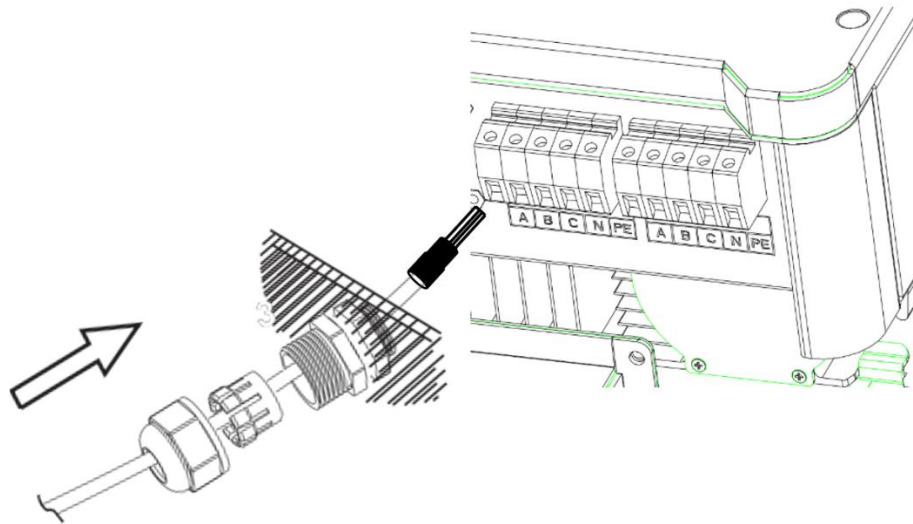



Table 5 Cable and Micro-breaker recommended

Model	BD8KTR-RH3	BD10KTR-RH3	BD12KTR-RH3
Cable	4-5 mm ²		5-6 mm ²
Micro-breaker	20A	32A	40A









Requirements for EPS load

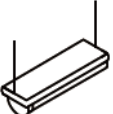
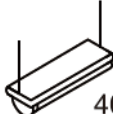

WARNING!
 Make sure the EPS load power rating is within EPS output rating, otherwise the inverter will shut down with an "over load" warning.
 When an "over load" is appeared, adjust the load power to make sure it is within the EPS output power range, then turn the inverter back on.

Below table shows some common feasible loads for you reference.

Type	Power		Common equipment	Example		
	Start	Rated		Equipment	Start	Rated
Resistive load	R 1	R 1	  Incandescent lamp TV	 100W Incandescent lamp	100VA (W)	100VA (W)
Capacitive load	R 2	R 1.5	 Fluorescent lamp	 40W Fluorescent lamp	80VA (W)	60VA (W)
Inductive load	R 3~5	R 2	  Fan Fridge	 150W Fridge	450-750VA (W)	300VA (W)

6.4 Battery Connection

Charging & discharging system of BD series hybrid inverter is designed for high-voltage lithium battery.

Before choosing battery, please note the maximum voltage of battery cannot exceed 600V and the battery communication should be compatible with BD series hybrid inverter.

Battery breaker

Before connecting to battery, please install a nonpolarized DC breaker to make sure inverter can be securely disconnected during maintenance

Model	BD8KTR-RH3	BD10KTR-RH3	BD12KTR-RH3
Voltage	Nominal voltage of DC breaker should be larger than maximum voltage of battery.		
Current [A]	80A		

Battery connection diagram

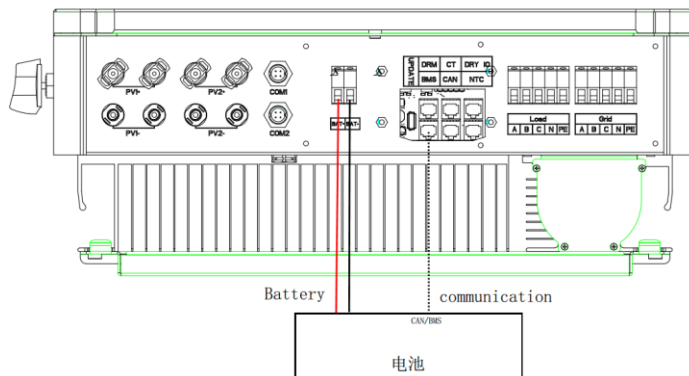

BMS PIN Defination

Communication interface between inverter and battery is RS485 or CAN with a RJ45 connector

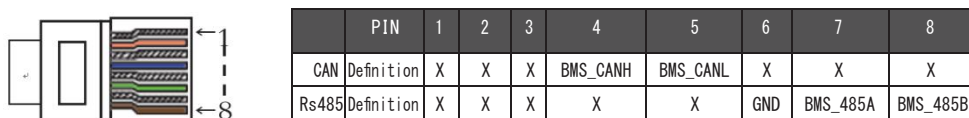

When using RS485 protocol, please note that PIN2 must be disconnected

 Note !

The battery communication can only work when the battery BMS is compatible with the inverter.

Power Connection Steps:

Step1,2,3. Choose the 10mm² wire and strip the cable to 15mm.

Step4. Remove waterproof cover plate.

Step5. Disassemble the waterproof connector and pass the cable through the waterproof connector.

Step6. Connect the cable to the terminal of the inverter.

Step6. Assemble waterproof connectors and waterproof covers plate.

Step1,2,3



Step 4, 5

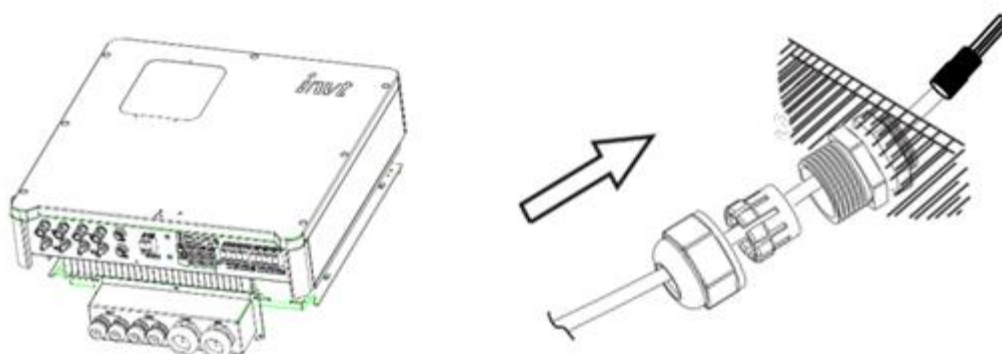

Step 6

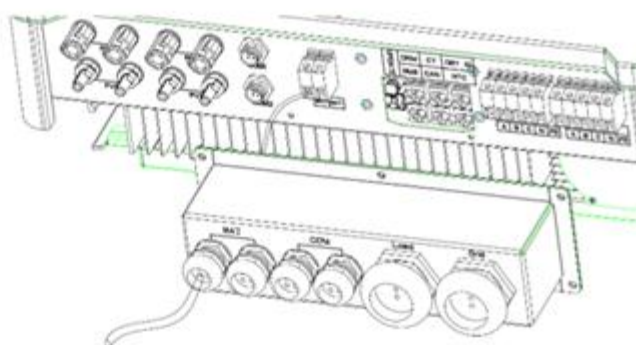

6.5 Meter Connection

Meter is used for monitoring the power usage for entire house, at the meantime, inverter will also need the data from Meter to achieve the Export Control Function.

Note !

 It is necessary to connect meter to inverter otherwise inverter will shut down with a "Meter fault" alert.

The meter communication only works when meter is compatible.

Meter connection diagram

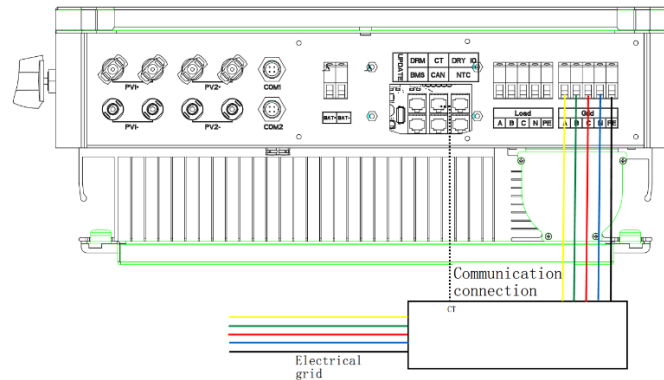

Meter PIN Defination

Communication interface between inverter and meter is RS485 with a RJ45 connector

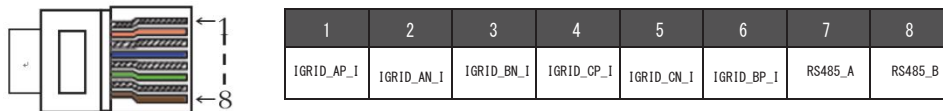

Meter Connection Steps:

Please refer to BMS connection steps (page32) for Meter connection. Please kindly noted the PIN defination and port position will be slightly different.

Step1. Disassembly of waterproof connectors and waterproof covers.

Step2. Prepare a communication cable (without sheath) and pass the cable through the waterproof connector.

Step3. Insert one Rj45 side of the cable into Meter port inside of inverter and the other side into BMS-485port of the meter.

Step4. Assemble waterproof connectors and waterproof covers plate.

Step 1,2

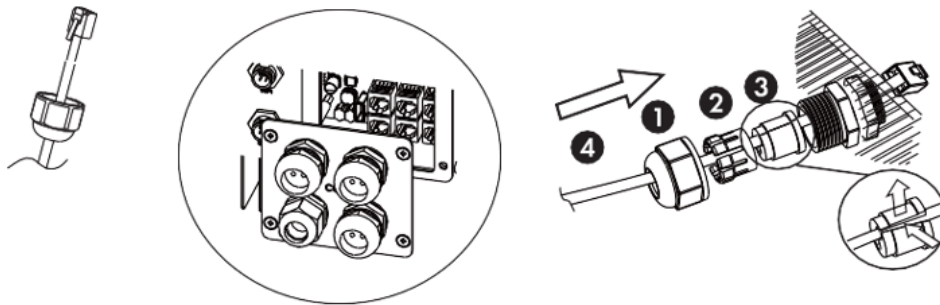

The seal is used for waterproof. Please make sure it has been kept back.

Step 3

DRM	CT	Dry contact
BMS-485	Parallel	NTC
BMS-CAN		

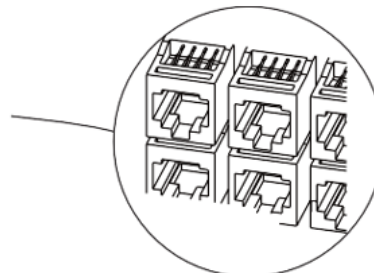

Step 4

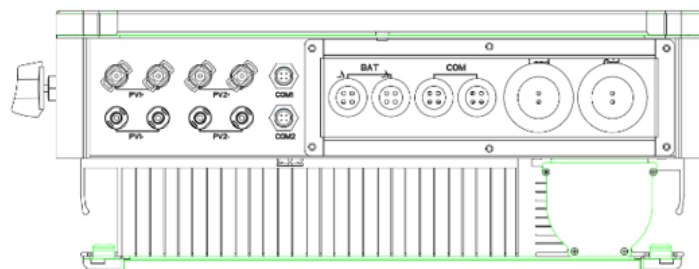

6.6 DRM Connection

DRM is provided to support several demand response modes by emitting control signals as below.

Note: Only PIN6(DRM0) is available now, and other PIN functions are being developed

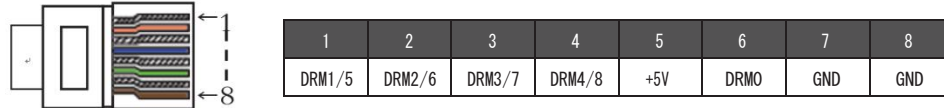

DRM Connection Steps:

Please refer to BMS connection steps (page32) for DRM connection. Please kindly noted the PIN definition and port position will be slightly different.

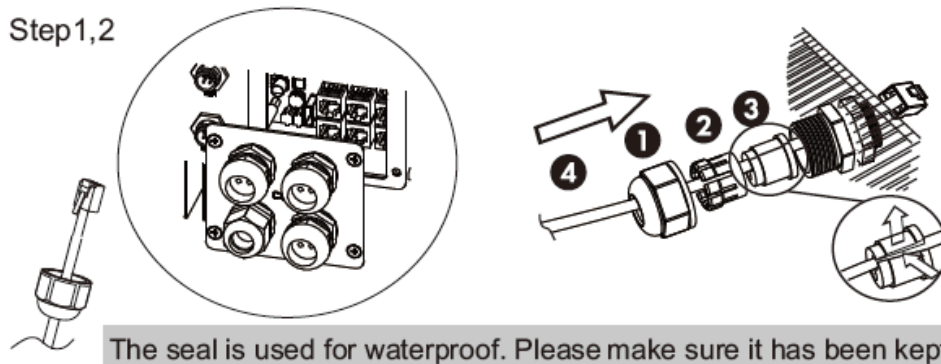

Step3

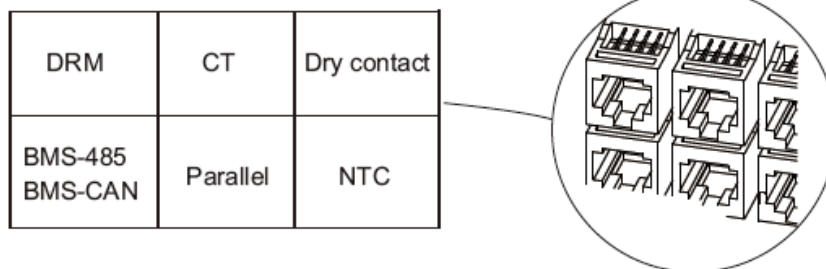

Step 4

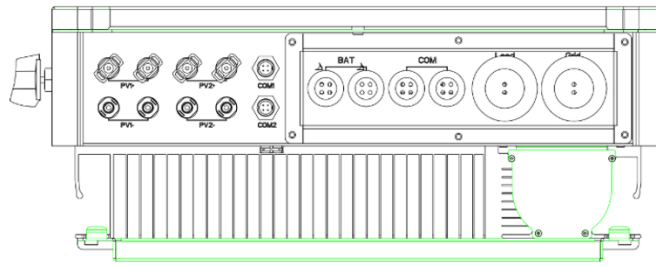

6.7 WiFi Connection(optional)

Inverter provides a WIFI port which can collect data from inverter and transmit it to monitoring website by WIFI.

(Purchase the product from supplier if needed)

Diagram

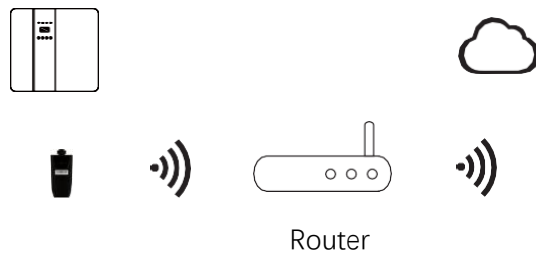

WiFi Connection Steps:

Step1. Plug Wifi logger into "WIFI" port at the bottom of the inverter.

Step2. Build the connection between the inverter and router.

Step3. Create a user account online. (Please check the WIFI user manual for more details).

Please connect to the port above

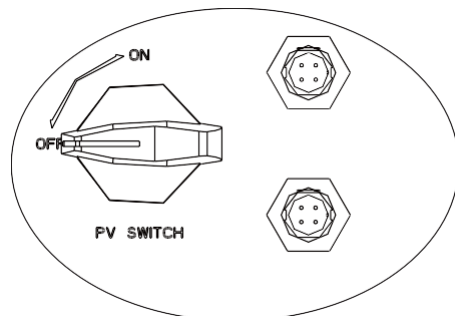

6.8 GPRS Connection (optional)

BD series hybrid inverter provides a GPRS (radio frequency) interface which controls the switchtime of a designated load via an external Smart Plug (purchase the product from supplier if needed.) so that the load mostly consumes PV energy and incurs the lowest-possible energy costs during operation.

Diagram

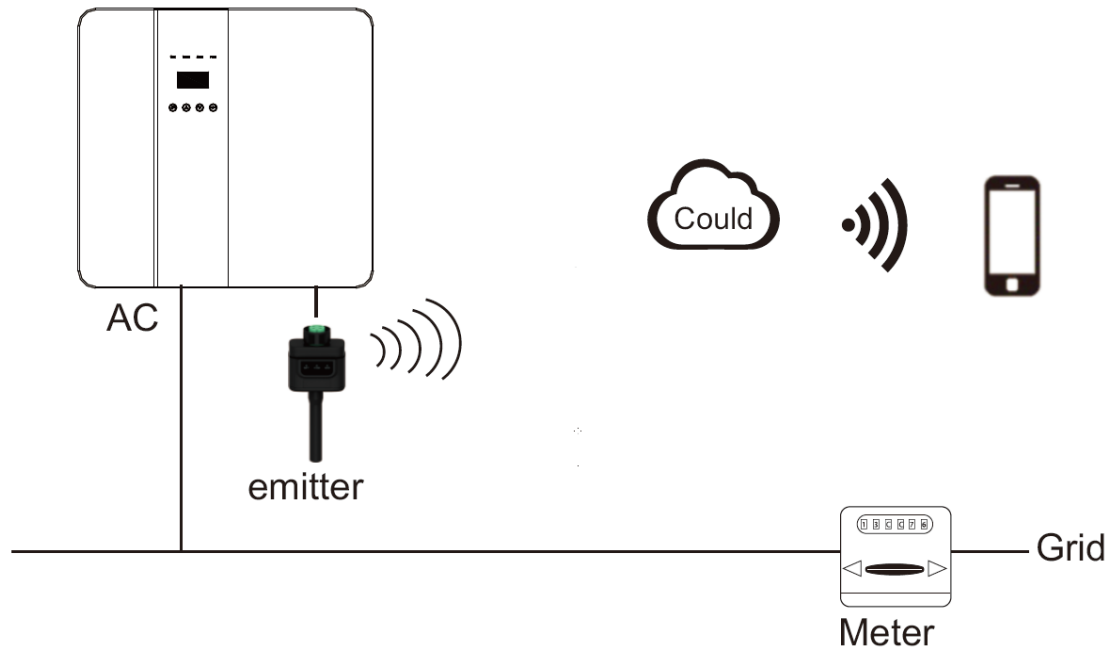

GPRS Connection Steps:

Please refer to the Smart Plug user manual for detailed connection steps.

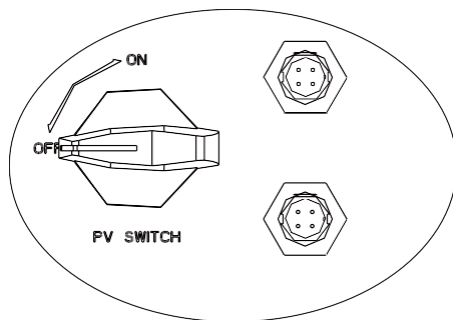

Please connect to the port below

6.9 Inverter Manipulation

Start inverter after checking all below steps:

Ensure the inverter fixed well on the wall.

Make sure all the DC wirings and AC wirings are completed.

Make sure the meter is connected well. Make sure the battery is connected well.

Make sure the external EPS contactor is connected well.

Turn on the AC switch and EPS switch

Turn on the PV/DC switch and battery switch

Check the inverter:

Step1. Check the status of indicators and LCD screen.the indicator screen should display the main interface

Note !



If the left indicator is not blue please check below the three points:

- All the connections are correct.
- All the external breakers are switched on.
- The DC switch on the inverter is in the "ON" position.

Step2. If it is the first time to start up,please follow it. For specific setting,refer to section 8 (Setting).

Step3. Set WiFi according to wifi user manual. Step4. Operate "Self Test". (Apply to Italy only)

Self-test in accordance with CEI 0-21(Apply to Italy only)

The self-test is only required for inverters which are commissioned in Italy. The Italian standard requires that all inverters feeding into the utility grid are equipped with a self-test function in accordance with CEI 0-21. During the self-test, the inverter will consecutively check the protection reaction times and values for over-voltage, under-voltage, over-frequency and under-frequency.

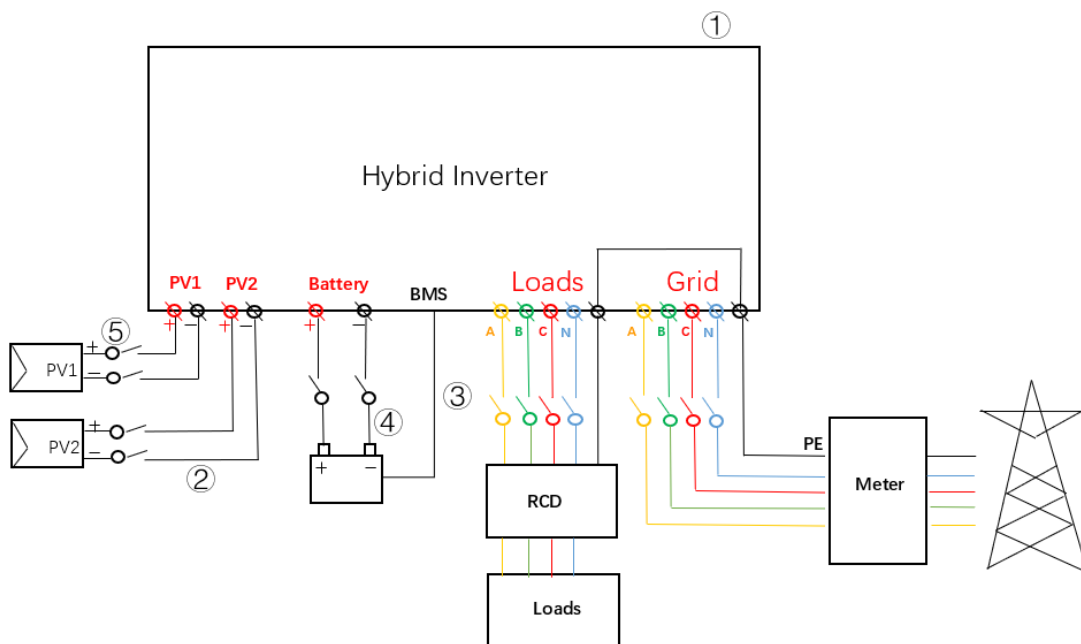

7. Setting

7.1 Control Panel

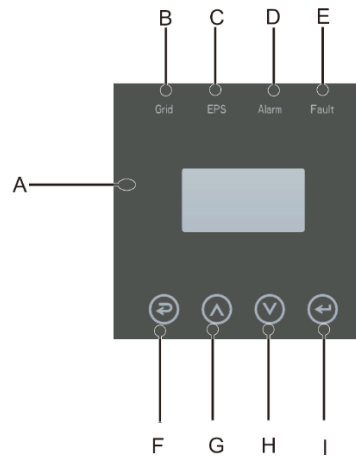

Object	Name	Description
A	LCD Screen	Display the information of the inverter.
B	Indicator LED	lit in green: The inverter is in grid mode. Off : The inverter is in not in grid mode.
C		lit in green: The inverter is in off-grid mode. Off : The inverter is in not in off-grid mode.
D		lit in Yellow: The inverter is in Warning . Off : The inverter has no Inverter Warning
E		lit in red: The inverter is in fault status. Off : The inverter has no errors.
F	Function Button	Esc: Return from current interface or function.
G		Up: Move cursor to upside or increase value.
H		Down: Move cursor to downside or decrease value.
I		Enter: Confirm the selection.

7.2 Instructions for LED Indicator

	Grid (Green)	EPS (Green)	Alarm (Yellow)	Fault (Red)
Initialization	off	off	off	off
Stand-by	off	off	off	off
Grid mode	on	off	off	off
Off -Grid	off	on	off	off
Bypass of mains	off	on	on	off
Fault	off	off	off	on

7.3 Instructions for the use of three modes

(1) Before selecting the mode, you can set it up according to the local power grid, PV input mode and battery type.

Power grid :

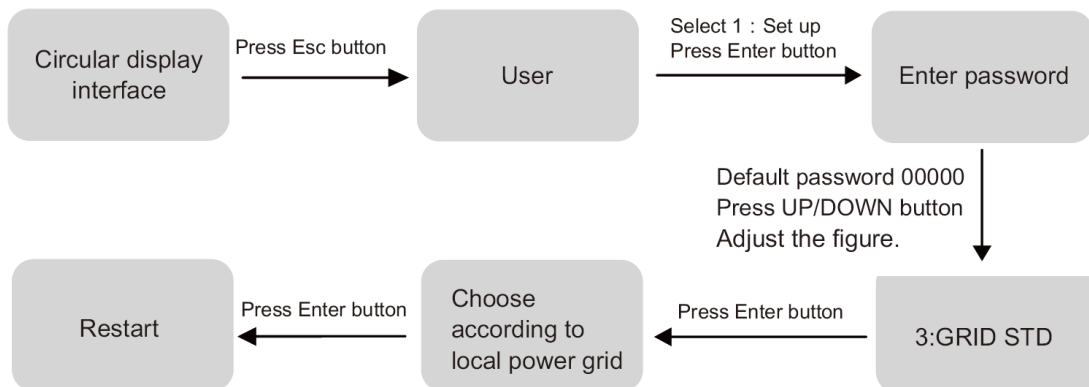

Note: If local grid connection requires reactive power, please set the required reactive power according to the following reference

7.3.1 Set according to actual needs

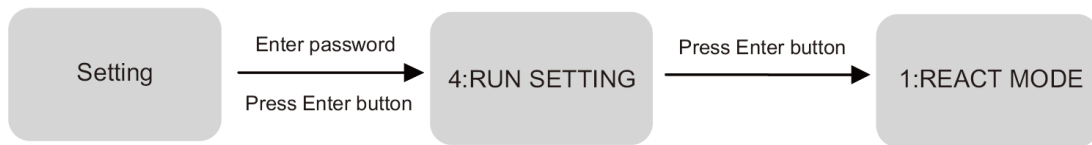

PV input mode :

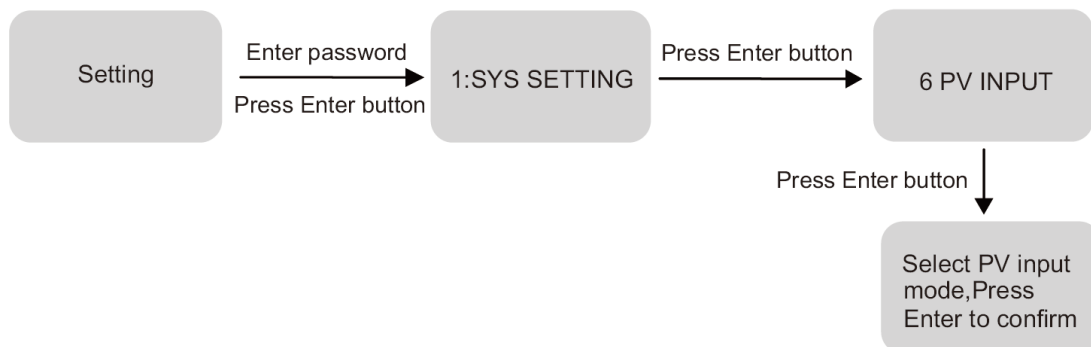

Battery parameters :

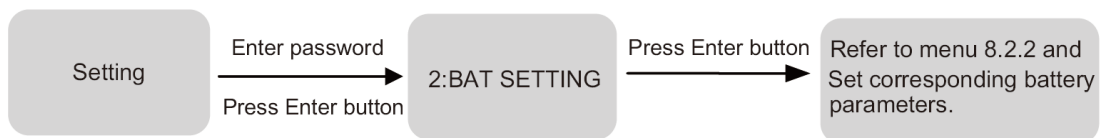

Peak load shifting :

After finishing the setting of Peak load shifting mode the charging and discharging time also need to be set up.

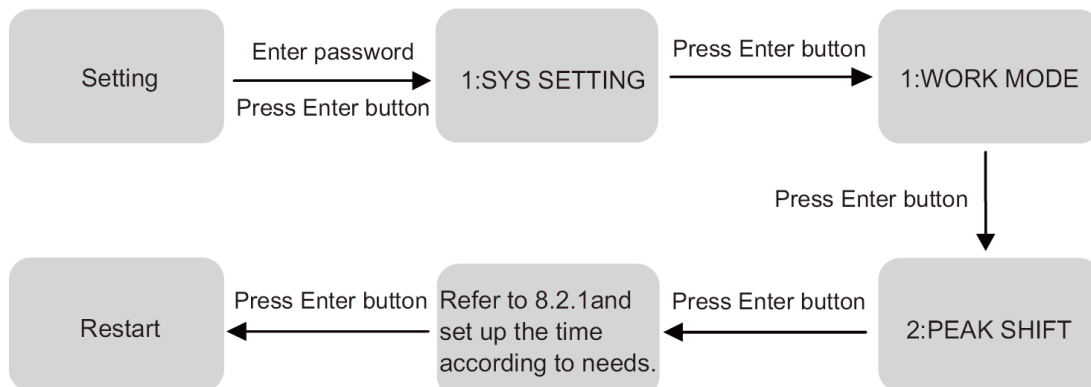

Note: If the time setting is not correct, you need to set the correct time before pressing Enter to exit the interface.

(2) Select the corresponding mode based on actual situation
Self-generation and self-consumption (system default mode)

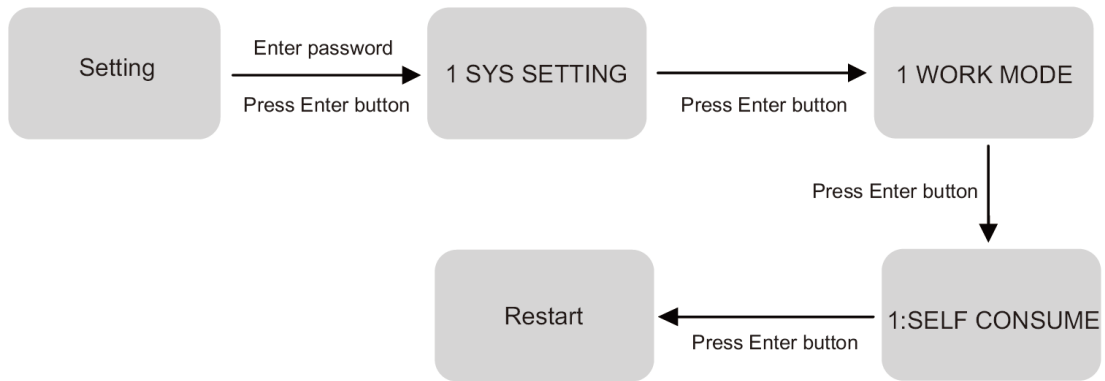

If you want to set up more items, please restart after completing the setup.
Battery priority :

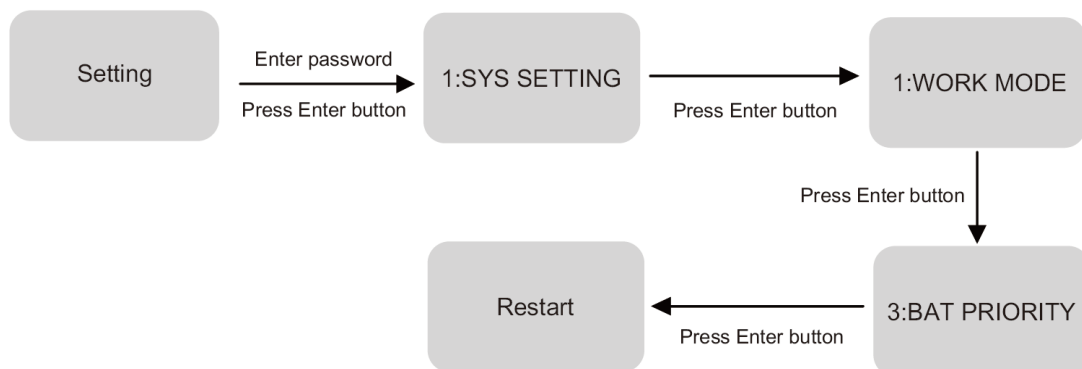

Note:When choosing battery priority mode, the corresponding charging current should be opted for according to the battery type.
The system default current is 25A.

8. LCD Operation

8.1 LCD Interface

8.1.1 PV1 input display interface

Interface		
PV1 INPUT		
VOLT :	33.8V	PV 1 input real-time voltage
CURR :	0.00A	PV 1 input real-time current
POWER :	0W	PV 1 input real-time power

8.1.2 PV2 input display interface

Interface		
PV1 INPUT		
VOLT :	33.8V	PV 1 input real-time voltage
CURR :	0.00A	PV 1 input real-time current
POWER :	0W	PV 1 input real-time power

8.1.3 Bus voltage

Interface	
DC VOLTAGE	
BUS :	33.8V → Real-time voltage of bus capacitor of the machine

8.1.4 Battery

Interface	
BATTERY	
VOLT :	48.9V → Real-time voltage of battery
CURR :	0.00A → Real-time battery current("+ means charge)

8.1.5 BMS parameters

Interface	
BATTERY INFOR	
TYPE : LEAD-ACID	Battery type: (lead acid, lithium battery)
TEMP : 0.0°C	Battery temperature
SOC : 60%	Percentage of battery surplus capacity

8.1.6 BMS parameters

Interface	
BMS PRMETER	The following parameters correspond to the set values
CHAR VOLT: 54.5V	Battery charging voltage
CHARGE : 25A	Battery charging current
DISCHA : 100A	Battery discharging current

8.1.7 Grid-connected output

Interface	
GRID OUTPUT	
VOLT : 0.0V	Grid real-time voltage
CURR : 0.00A	CT real-time current
FREQ : 0.00Hz	Grid real-time frequency

8.1.8 Inverter output

Interface	
INV OUTPUT	
VOLT : 0.0V	Inverter real-time voltage
CURR : 0.00A	Inverter real-time current
FREQ : 0.00Hz	Inverter real-time frequency

8.1.9 Load

Interface	
LOAD	
VOLT : 0.0V	Load side real-time voltage
CURR : 0.0A	Load side real-time current
PERCENT : 80%	Load side power percentage

8.1.10 Power

Interface	
POWER	
INV :	0.0W → Inverter side real-time power
GRID :	0.0W → Grid-side real-time power

8.1.11 Power

Interface	
POWER	
PV I/P :	0.0W PV side real-time power
LOAD :	0.0W Load side real-time power
BAT :	0.0W BAT side real-time power

8.1.12 Temperature

Interface	
TEMPERATURE	
INVER :	0.0°C Real-time Temperature of Inverter Side Radiator
DCDC :	0.0°C DCDC side radiator real-time temperature
INSIDE :	0.0°C Internal ambient temperature of the machine

8.1.13 Status information

Interface	Description
STATE SYS : STANDBY	System information:Display complete machine status information, Including:Initialization, Standy, PV grid connection, Grid connection of battery, Hybrid power supply, etc. INV:Displays the inverter status information. DCDC:Displays charging and discharging status information .
INV : STANDBY	
DCDC : STANDBY	

8.1.14 Error information

Interface	Description
ERROR NO. 02:BatDisconnect	Numbers represent error codes and text is error information. Refer to Chapter 9 for specific contents. NOTE:When there is a lock mark in the upper right corner of the screen, you cannot turn the page, you need to press Enter to unlock it first.

8.1.15 System setting

Interface	Description
-----------	-------------

<p>SYSTEM STATE : SELF CSM GRID : 220/50 PV I/P : PARALL</p>	<p>State:Setting of the whole machine working mode. Including: self-use, peak cutting and valley filling, battery priority.</p> <p>Grid connection standard:Displays the grid standard actually set.</p> <p>PV input mode:The display value is the setting value of PV input type. Including: independent, parallel, constant voltage.</p>
--	--

Press ESC button to enter user setting

8.1.16 User setting

Interface	Description
<p>USER →1 : SETUP 2 : INQUIRE 3 : STATISTIC</p>	<p>Press Esc to enter the user settings interface.</p> <p>See chapter 8.2 for more setting details.</p>

Enter the password before setting up the user

Interface	Description
<p>PASSWORD INPUT : XXXXX</p>	<p>Enter the password required for setting. The default password is: "00000" .</p> <p>Press the Up and Down keys to adjust the number, press the Enter key to move the cursor forward, and press the Esc key move the cursor backward.</p>

8.2 Setting

Interface	Description
--SETUP-- → 1 : SYS SETTING 2 : BAT SETTING 3 : GRID STD 4 : RUN SETTING 5 : 485 ADDRESS 6 : BAUD RATE 7 : LANGUAGE 8 : BACKLIGHT 9 : DATE/TIME 10 : CLEAR REC 11 : PASSWORD 12 : MAINTENANCE 13 : FCTRY RESET	This interface is used for various information inquiry options. Press the UP/DOWN button to make the corresponding selection. Press Enter button to enter the selected menu. Press ESC button return to the user interface. (refer to 8.1.16) There are 13 options in total, including system mode, battery parameters, grid standard, operation parameters, 485 address, 485 baud rate, language display, LCD backlight, date/time, clear history, password setting and maintenance, and factory reset.

8.2.1 System setting

Interface	Description
--SYS SETTING-- →1: WORK MODE 2: EPS ENABLE 3: BAT WAKE-UP 4: REMOTE CTRL 5: START DELAY 6: PV INPUT 7: Anti Reverse	This interface is used to access system information. Press UP/DOWN button to move corresponding options. Press ENTER to enter the selected menu. Press ESC button to return to the setting interface.

① WORK MODE

Interface	Description
--WORK MODE-- 1:SELF COMSUME → 2:PEAK SHIFT 3:BAT PRIORITY	This interface is used to select the working mode. Press ESC button return to setting interface. (refer to 8.2.1)

Select the peak clipping and valley filling mode, you also need to set the charge

and discharge time

Time setup

Interface	Description
CHAG START: 00:00 CHARGE END: 00:00 DISC START: 00:00 DISCHA END: 00:00	This interface is used to opt for the time of peak load shifting. Press Up/Down button to move the corresponding options. Press Enter to enter the selected menu. Press Esc button to return to the working mode interface.

② EPS ENABLE

Interface	Description
-- EPS ENABLE -- →1: DISABLE 2: ENABLE	When the Grid PV is powered off, Enable the battery to supply power to the load, default option is enable.

③ Battery wake up enable

Interface	Description
-- BAT WAKE-UP -- →1: DISABLE 2: ENABLE	Battery wake-up enable setting. The default option is disabled.

④ REMOTE CTRL

Interface	Description
--REMOTE CTRL-- →1: DISABLE 2: ENABLE	When you want to remotely control the machine, you need to enable it. Default option is disabled.

⑤ START DELAY

Interface	Description
-----------	-------------

<p>--START-UP DELAY-- INPUT: 60 UINT: SEC</p>	<p>The input value ranges from 20 to 300, which varies with different standards.</p>
---	--

⑥ PV INPUT

Interface	Description
<p>--INPUT MODE-- →1: INDEPENDANT 2: PARALLEL 3: CV</p>	<p>Setup of PV Input mode. The factory setting by default is Independent, When parallel input is set to be stand-alone mode, PV power will be imbalanced.</p>

8.2.2 BAT SETTING

Interface	Description
<pre>--BAT SETTING-- 1:BAT TYPE → 2:DISC-DEPTH 3:CHARGE-CURR</pre>	<p>This interface is used to select battery parameters.</p> <p>Press UP/DOWN button to move corresponding options;</p> <p>Press ENTER button to enter the selected menu;</p> <p>Press ESC button to return to setting interface.</p>

① Battery type

Interface	Description
<pre>--BAT TYPE-- 1: LEAD-ACID →2: CUSTOM-Li 3: PYLON-Li 4: RICHPOW-Li 5: TOPBANG-Li</pre>	<p>This interface is used to select battery type.</p> <p>Press UP/DOWN button to move corresponding options;</p> <p>Press ENTER button to enter the selected menu.</p> <p>Select the LEAD-ACID enter button to enter LEAD-ACID interface;</p> <p>Select the CUSTOM-Li enter button to enter the CUSTOM-Li interface;</p> <p>Select the PYLON_Li enter button to enter the restart interface.</p>

CUSTOM-Li battery parameter

Interface	Description
<pre>--CUSTOM-Li BAT-- 1:CHARG-VOLT → 2:BAT END VOLT 3:BAT OVP</pre>	<p>This interface is used to select CUSTOM-Li battery parameter.</p> <p>Press Up/Down button to move corresponding options;</p> <p>Press ENTER button to enter the selected menu;</p>

Lead-acid battery parameter

Interface	Description
<pre>--LEAD-ACID-- → 1:CHARG-VOLT 2:BAT END VOLT 3:BAT OVP 4:BAT CAP</pre>	<p>This interface is used to select LEAD-ACID battery parameter.</p> <p>Press Up/Down button to move corresponding options;</p> <p>Press Enter button to enter the selected menu;</p>

① Charge voltage

Interface	Description
<pre>--CHARGE VOLT-- INPUT : 56.5 UNIT : V</pre>	<p>Press Up/Down button to increase or decrease the input figure;</p> <p>Press the Enter key to move the cursor backward, confirm the input and return to the battery parameter interface.</p> <p>Press Esc button to cancel the selection and return to battery parameters interface.</p>

② BAT END VOLT

Interface	Description
<pre>--BAT END VOLT-- INPUT : 43.2 UNIT : V</pre>	<p>Press Up/Down button to increase or decrease the input figure;</p> <p>Press Enter to move cursor backward, confirm input and return to battery parameters interface;</p> <p>Press ESC button to move cursor forward and return to battery parameters interface.</p>

③ BAT OVP

Interface	Description
<pre>--BAT OVP-- INPUT : 56. 5 UNIT : V</pre>	<p>Press Up/Down button to increase or decrease the input figure;</p> <p>Press Enter button to move cursor backward, confirm input and return to battery parameters interface;</p> <p>Press Esc button to move cursor forward and return to battery parameters interface.</p>

④ Battery capacity

Interface	Description
--BAT CAP-- INPUT : 100 UNIT : AH	Press Up/Down button to increase or decrease the input figure; Press Enter to move cursor backward, confirm input and return to battery parameters interface; Batteries capacity with a range of 50~1000;

8.2.3 Grid standard

Interface	Description
--GRID STD-- → 1:220V/50HZ 2:230V/50HZ 3:240V/50HZ 4:220V/60HZ 5:230V/60HZ 6:240V/60HZ	Press Up/Down button to move corresponding options; Press the Enter key to confirm the selection. Press ESC button to cancel the selection and return to setting interface (refer to 8.2).

8.2.4 RUN SETTING

Interface	Description
--RUN SETTING-- → 1: REACT MODE 2: GRID POWER 3: DISC POWER 4: VAC-MIN 5: VAC-MAX 6: FAC-MIN 7: FAC-MAX	Press Up/Down button to move corresponding corresponding options; Press Enter to enter the selected menu; Press ESC button to return to setting interface.

① Reactive mode

Interface	Description
<pre>--REACT MODE-- → 1:POWER FACTOR 2:REACT POWER 3:QU WAVE 4:QP WAVE</pre>	<p>Press Up/Down button to move corresponding options;</p> <p>Press Enter to confirm the input and enter power factor setting interface; (select 2, press Enter to confirm input and enter reactive power interface; Select 3, 4, the corresponding mode will be selected and return to the parameter setting interface.)</p> <p>Press Esc button to cancel the input and return to operation parameters interface.</p>

Power factor setting

Interface	Description
<pre>-POWER FACTOR- INPUT: C1.00 Value range (L1.00~C1.00)</pre>	<p>Press Up/Down to increase or decrease the input figure;</p> <p>Press Enter button to confirm or Esc button to cancel the input and return to working interface;</p> <p>The input value should range between L0.80 and L0.99 or C0.8 and C1.00.</p>

Reactive Power

Interface	Description
<pre>-REACT POWER- INPUT: +60% Value range (-60%~+60%)</pre>	<p>Press Up/Down button to adjust the input figure.</p> <p>Press Enter button to confirm or Esc button to cancel the input and return to working interface;</p> <p>The input value should range between -60% and +60%, which varies with the standard.</p>

② Grid-connected power

Interface	Description
<pre>-GRID PERCENT- INPUT : 100% Value range (0~100)</pre>	<p>Press Up/Down button to adjust the input figure;</p> <p>Press Enter button to confirm or Esc button to cancel the input and return to operation parameters interface;</p> <p>The input value should range between 0 and 100.</p>

③ Discharge power

Interface	Description
-DISC PERCENT- INPUT : 050% Value range (0~100)	Press Up/Down button to adjust the input figure; Press Enter button to confirm or Esc button to cancel the input and return to operation interface; The input value should range between 0 and 100.

④ VAC-MIN

Interface	Description
-GRID VOLT LOW- INPUT : UNIT : V Value range (176~270V)	Grid Low Voltage Protection Point . Press Up/Down to adjust the input figure; Press Enter to confirm the input. Press ESC button to cancel the input and return to operation parameters interface; The value should range between 176V and 270, which varies with different standards.

⑤ VAC-MAX

Interface	Description
-GRID VOLT HIGH- INPUT : UNIT : V Value range (240~280V)	Grid Over Voltage Protection Point. Press Up/Down to adjust the input figure; Press Enter to confirm the input. Press Esc to cancel the input and return to operation parameters interface; The value should range between 240V and 280V, which varies with different standards.

⑥ FAC-MIN

Interface	Description
-GRID FREQ LOW- INPUT : UNIT : Hz Value range (45~49.8)	Grid Low Frequency Protection Point Press Up/Down to adjust the input figure; Press Enter to confirm the input. Press Esc to cancel the input and return to operation parameters interface; The value ranges between 45 and 49.8, which varies with different standards.

⑦ FAC-MAX

Interface	Description
-GRID FREQ HIGH- INPUT : 52.0 UNIT : Hz Value range (50.2~55V)	Grid Over Frequency Protection Point. Press Up/Down to adjust the input number; Press Enter to confirm the input. Press ESC to cancel the input and return to operational parameters interface; The value ranges between 50.2 and 55, which varies with different standards.

8.2.5 485 Address

Interface	Description
--485 ADDRESS-- INPUT : 1 Value range (1~64)	Press Up/Down button to adjust the input figure; Press Enter button to confirm or Esc button to cancel the input and return to setup interface; The input value should range between 1 and 64.

8.2.6 485 Baud rate

Interface	Description
--BAUD RATE-- 1:2400bps 2:4800bps →3:9600bps	Press Up/Down button to move corresponding options; Press Enter button to confirm or Esc button to cancel the selection and return to setup interface; There are three alternative options: 2400/4800/9600.

8.2.7 Language

Interface	Description
--SELECT-- 1:CHINESE →2:ENGLISH	Press Up/Down button to move corresponding options; Press Enter button to confirm or Esc button to cancel the selection and return to setup interface;

8.2.8 LCD backlight

Interface	Description
<pre>--LIGHT TIME-- INPUT : 20 UNIT : SEC Value range (20~120)</pre>	<p>Press Up/Down button to adjust the input figure.</p> <p>Press Enter button to confirm or Esc button to cancel the input and return to setup interface;</p> <p>The input value should range between 20 and 120.</p>

8.2.9 Date/time

Interface	Description
<pre>--DATE/TIME-- DATE : 2099-01-12 TIME : 10 : 00 : 00 WEEK : Monday</pre>	<p>Press Up/Down button to adjust the input figure.</p> <p>Press Enter button to move cursor backward, confirm input and return to setup interface;</p> <p>Press Esc button to move cursor forward and return to setup interface;</p> <p>The input value should range between 2000 and 2099.</p>

8.2.10 Clear history

Interface	Description
<pre>--DEL REC -- 1:CANCEL →2:CONFIRM</pre>	<p>Clear all the previous history in Inquiry/Record menu.</p> <p>Press Up/Down button to move corresponding options;</p> <p>Press Enter button to confirm or Esc button to cancel the selection and return to setup interface.</p>

8.2.11 Password Setting

Interface	Description
<pre>--PASSWORD-- OLD: XXXXX NEW: XXXXX CONFIRM:XXXXX</pre>	<p>This interface will be used to change password for entry into the setup interface;</p> <p>Press Up/Down to adjust the input figure;</p> <p>Press Enter to move cursor backward, confirm input and return to setup interface;</p> <p>Press ESC to move cursor forward and return to setup interface;</p>

8.2.12 Maintenance

Interface	Description
--PASSWORD-- INPUT: XXXXX	Maintainer use only.

8.2.13 Factory reset

Interface	Description
-FACTORY RESET- →1: CANCEL 2: CONFIRM	Press Up/Down button to move corresponding options; Press Enter to enter the selected item.

8.2.14 Inquiry

Interface	Description
--INQUIRE-- →1: INV MODULE 2: MODULE SN 3: FIRMWARE 4: RECORD	Press Up/Down button to move corresponding options; Press Enter button to jump to the selected menu. Press ESC button to return to user interface. (refer to 8.1.16);

① INV MODULE

Interface	Description
--MODEL-- R5KL1	This interface displays machine model of the inverter; Press Esc button to return to inquiry interface.

② MODULE SN

Interface	Description
--S/N-- GUID: 05DBFF38 430987323639424E	This interface displays serial number of the the inverter; This is unique for any device and in any context.

③ Firmware Version

Interface	Description
<pre>--FIRMWARE-- ARM: V1.00.00 DSP: V1.00.00</pre>	<p>This interface displays firmware version for ARM and DSP of the inverter;</p> <p>Press ESC button to return to inquiry interface.</p>

④ Running records

Interface	Description
<pre>--REC(01)-- 02:BatDisconnec t UP: 01-12 00:00 DOWN:</pre>	<p>SN of the fault: Fault warning codes (500 at utmost) (the latest fault or alarm marked as No. 1)</p> <p>UP:Time of the fault.</p> <p>Press Up/Down button to view the record;</p> <p>Press Enter button to enter the description interface for corresponding records;</p> <p>Press ESC button to return to Inquiry interface.</p>

8.2.12 Statistics

Interface	Description
<pre>--STAT-- →1:TIME STAT. 2:CONNE. TIMES 3:PEAK POWER 4:E-TODAY 5:E-MONTH 6:E-YEAR 7:E-TOTAL</pre>	<p>This interface is used to select statistics items;</p> <p>Press Up/Down button to move corresponding options;</p> <p>Press Enter to enter the selected menu;</p> <p>Press ESC button to return to user interface.</p>

① TIME STAT

Interface	Description
<pre>--Time-- RUN: 5 GRID: 0 UNIT: HOUR</pre>	<p>Operation length of inverter (hours)</p> <p>Grid-connection length (hours)</p> <p>Press ESC button to return to statistics interface.</p>

② CONNE. TIMES

Interface	Description
<pre>-- CONNE. TIMES -- TIMES : 0</pre>	<p>This interface displays grid-connection frequency of the inverter.</p> <p>Press ESC button to return to statistics interface.</p>

③ Peak power

Interface	Description
<pre>--PEAK POWER-- HISTORY : 5000 TODAY: 0 UNIT : W</pre>	<p>This interface displays power peak in history and for the day.</p> <p>Press ESC button to return to statistics interface.</p>

④ E-TODAY

Interface	Description
<pre>--E-TODAY-- PV : 0.0KWH GRID: 0.0KWH CNSUM : 0.0KWH</pre>	<p>This interface displays power generation for the day (KWH).</p> <p>PV power generation;</p> <p>Grid-connection power generation;</p> <p>Power consumption of load and inverter;</p> <p>Press ESC button to return to statistics interface.</p>

⑤ E-MONTH

Interface	Description
<pre>--E-MONTH-- PV : 0.0KWH GRID: 0.0KWH CNSUM 0.0KWH</pre>	<p>This interface displays power generation for the month (KWH).</p> <p>PV power generation;</p> <p>Grid-connection power generation;</p> <p>Power consumption of load and inverter;</p> <p>Press ESC button to return to statistics interface.</p>

⑥ E-YEAR

Interface	Description
-----------	-------------

<p>--E-YEAR-- PV : 0.0KWH GRID: 0.0KWH CNSUM : 0.0KWH</p>	<p>This interface displays power generation for the year (KWH); PV power generation; Grid-connection power generation; Power consumption of load and inverter; Press ESC button to return to statistics interface.</p>
--	--

⑦ E-TOTAL

Interface	Description
<p>--E-TOTAL-- PV : 0.0KWH GRID: 0.0KWH CNSUM : 0.0KWH</p>	<p>This interface displays gross power generation; PV power generation; Grid-connection power generation; Power consumption of load and inverter; Press ESC button to return to statistics interface.</p>

9. Fault diagnosis and solutions

The inverter is easy to maintain. When you encounter the following problems, please refer to the Solutions below, and contact the local distributor if the problem remains unsolved. The following table lists some of the basic problems that may occur during the actual operation as well as their corresponding basic solutions.

Fault diagnosis table

Content	Codes	Solutions
DischgOverCur	00 29	<p>(1) nothing need to do, Wait one minute for the inverter to restart.</p> <p>(2) Check whether the load is in compliance with the specification.</p> <p>(3) Cut off all the power and shut down all the machines; disconnect the load and plug in to restart machines, then check whether the load is short circuited if the fault has been eliminated.</p> <p>(4) Contact customer service if error warning continues.</p>
Over Load	01	<p>(1) Check whether the load is in compliance with the maximum power of the machine.</p> <p>(2) Cut off all the power and shut down all the machines; disconnect the load and plug in to restart machines, then check whether the load is short circuited if the fault has been eliminated.</p> <p>(3) Contact customer service if error warning continues.</p>
BatDisconnect	02	<p>(1) Check if the battery not connected.</p> <p>(2) Check if battery wiring port is open circuited .</p> <p>(3) Contact customer service if error warning continues.</p>
Bat Under Vol	03 04 26	<p>(1) Check if the battery is in line with the presetting. If so, power off and restart.</p> <p>(2) Check if the grid is powered down. If the power is off , wait for the grid to powered up, the grid will automatically charge the battery.</p> <p>(3) Contact customer service if error warning continues.</p>

Bat Over Vol	05 27	(1) Check if the battery is in line with the presetting. If so, power off and restart. (2) Contact customer service if error warning continues.
grid low vol	06	(1) Check if the grid is abnormal. (2) Restart the inverter and wait until it functions normally. (3) Contact customer service if error warning continues.
grid over vol	07	(1) Check if the grid is abnormal. (2) Restart the inverter and wait until it functions normally. (3) Contact customer service if error warning continues.
grid low freq	08	(1) Check if the grid is abnormal. (2) Restart the inverter and wait until it functions normally. (3) Contact customer service if error warning continues.
grid overFreq	09	(1) Check if the grid is abnormal. (2) Restart the inverter and wait until it functions normally. (3) Contact customer service if error warning continues.
gfci over	10	(1) Check PV string for direct or indirect grounding phenomenon. (2) Check peripherals of machine for current leakage. (3) Contact the local inverter customer service if fault remains unremoved.
SolarUnconnect	11	(1) PV is not connected. (2) PV switch is not closed. (3) Check PV availability.
Grid CtReverse	12	(1) Check whether the CT is connected in the correct direction. (2) Contact customer service if error warning continues.

bus under vol	13	(1) Check the input mode setting is correct. (2) Restart the inverter and wait until it functions normally. (3) Contact customer service if error warning continues.
bus over vol	14	(1) Check the input mode setting is correct. (2) Restart the inverter and wait until it functions normally. (3) Contact customer service if error warning continues.
inv over cur	15	(1) Restart the inverter and wait until it functions normally. (2) Contact customer service if error warning continues.
chg over cur	16	(1) Check if battery wiring is short circuited. (2) Check if charging current is in compliance with presetting. (3) Contact customer service if error warning continues.
bus vol osc inv under vol inv over vol InvFreqAbnor	17 18 19 20	(1) Cut off all the power and shut down all the machines and restart. (2) Contact customer service if error warning continues.
env temp high	21	(1) Cut off all the power of the machine and wait one hour, then turn on the power of the machine. (2) Contact customer service if error warning continues.
bat over temp	23	(1) Disconnect the battery and reconnect it after an hour. (2) Contact customer service if error warning continues.
Bat UnderTemp	24	(1) Check the ambient temperature near the battery to see if it meets the specifications. (2) Contact customer service if error warning continues.
BatCellUnball	25	(1) Break the grid, use the battery to supply power to the load, reconnect the grid side switch after half an hour, Wait another half an hour and check the fault status again. (2) Contact customer service if error warning continues.

chg over cur	28	(1) Check if battery wiring port is short circuited . (2) Check if charging current is in compliance with presetting. (3) Contact customer service if error warning continues.
bus soft fail inv soft fail bus short inv short fan fault BusRelayFault t GridRlyFault EPS rly fault gfcI fault Load Ct fault Off gridRlyFault l system fault	32 33 34 35 36 38 39 40 41 42 44 45	(1) Restart the inverter and wait until it functions normally. (2) Contact customer service if error warning continues.
pviso low	37	(1) Check if the PE line is connected to the inverter and is connected to the ground. (2) Contact customer service if error warning continues.
pv short	43	(1) Restart the inverter and wait until it functions normally. (2) Disconnect the PV input, restart the inverter and wait until it functions normally. (3) Contact customer service if error warning continues.
bat reverse	46	(1) Check if the inverter battery positive and negative connection is correct. (2) Contact customer service if error warning continues.