



BD Series Hybrid Inverter User Manual

INVT Solar Technology (Shenzhen) Co., Ltd.

Address: 6th Floor, Block A, INVT Guangming Technology Building,
Songbai Road, Matian, Guangming District, Shenzhen, China.

Postcode: 518106

Web: www.invt-solar.com

E-mail: solar@invt.com.cn

深圳市英威腾光伏科技有限公司
INVT Solar Technology (Shenzhen) Co., Ltd

Contents

1. Introduction	01
1.1 Important Safety Instructions	01
1.2 Explanation of Symbol	02
1.3 Basic features	03
1.4 Work Modes	04
1.5 Dimension	05
2. Interface definition and Technical Data	06
2.1 Interface definition	06
2.2 Technical Data	07
2.3 Basic Data	08
2.4 Safety and Protection	08
3. Installation	09
3.1 Check for Physical Damage	09
3.2 Packing List	09
3.3 Tools required for installation	09
3.4 Mounting	10
4. Electrical Connection	11
4.1 Grid connection and EPS connection	11
4.2 PV connection	13
4.3 Battery Connection	14
4.4 Communication interface definition	15
4.5 WiFi And GPRS Connection(optional)	16
5. Setting	17
5.1 Control Panel	17
5.2 Instructions for LED Indicator	17
5.3 Instructions for the use of three modes	18
5.4 LCD Interface	20
5.5 Settings	24
5.6 Inquire	34
5.7 Statistic	35
5.8 Autotest Fast	36
6. Fault diagnosis and solutions	38

1. Introduction

1.1 Important Safety Instructions



Danger!

- Danger to life due to high voltages in the inverter!
- All work must be carried out by qualified electrician.
- The appliance is not to be used by children or persons with reduced physical sensory or mental capabilities, or lack of experience and knowledge, unless they have been given supervision or instruction.
- Children should be supervised to ensure that they do not play with the appliance.



Caution!

- Danger of burn injuries due to hot enclosure parts!
- During operation, the upper lid of the enclosure and the enclosure body may become hot.
- Only touch the lower enclosure lid during operation.



Caution!

- Possible damage to health as a result of the effects of radiation!
- Do not stay closer than 20 cm to inverter for any length of time.



Note!

- Grounding the PV generator.
- Comply with the local requirements for grounding the PV modules and the PV generator. It recommends connecting the generator frame and other electrically conductive surfaces in a manner which ensures continuous conduction and ground these in order to have optimal protection of system and persons.



Warning!

- Ensure input DC voltage \leq Max. DC voltage .Over voltage may cause permanent damage to inverter or other losses, which will not be included in warranty!



Warning !











- Authorized service personnel must disconnect both AC and DC power from inverter before attempting any maintenance or cleaning or working on any circuits connected to inverter.
- Risk of electric shock!

- Accessories only together with the inverter shipment are recommended here. Other wise may result in a risk of fire, electric shock, or injury to person.
- Make sure that existing wiring is in good condition and that wire is not undersized.
- Do not disassemble any parts of inverter which are not mentioned in installation guide. It contains no user-serviceable parts. See Warranty for instructions on obtaining service. Attempting to service the inverter yourself may result in a risk of electric shock or fire and will void your warranty.
- Keep away from flammable, explosive materials to avoid fire disaster.
- The installation place should be away from humid or corrosive substance.
- Authorized service personnel must use insulated tools when installing or working with this equipment.
- PV modules shall have an IEC 61730 class A rating.
- Never touch either the positive or negative pole of PV connecting device. Strictly prohibit touching both of them at the same time.
- The unit contains capacitors that remain charged to a potentially lethal voltage after the MAINS , battery and PV supply has been disconnected.
- Hazardous voltage will present for up to 5 minutes after disconnection from power supply.
- CAUTION-RISK of electric shock from energy stored in capacitor, Never operate on the inverter couplers, the MAINS cables, Battery cables, PV cables or the PV generator when power is applied. After switching off the PV , battery and Mains, always wait for 5minutes to let the intermediate circuit capacitors discharge before unplugging DC , battery inplug and MAINS couplers.
- When accessing the internal circuit of inverter, it is very important to wait 5 minutes before operating the power circuit or demounting the electrolyte capacitors inside the device. Do not open the device before hand since the capacitors require time sufficiently discharge!

1.2 Explanation of Symbol

This section gives an explanation of all the symbols shown on the inverter and on the type label.

- Symbols on the Type Label

Symbol	Explanation
	CE mark. The inverter complies with the requirements of the applicable CE guidelines.
	TUV certified.
	RCM remark.
	SAA certification.
	Beware of hot surface. The inverter can become hot during operation. Avoid contact during operation.
	Danger of high voltages. Danger to life due to high voltages in the inverter!
	Danger. Risk of electric shock!
	Observe enclosed documentation.
	The inverter can not be disposed together with the household waste. Disposal information can be found in the enclosed documentation.
	Do not operate this inverter until it is isolated from battery, mains and on-site PV generation suppliers.
	Danger to life due to high voltage. There is residual voltage existing in the inverter after powering off, which needs 5 min to discharge. • Wait 5 min before you open the upper lid or the DC lid.

1.3 Basic features

BD seires hybrid inverter is a high quality inverter which can convert solar energy to AC energy and store energy into battery.

The inverter can be used to optimize self consumption, store in the battery for future use or feedin to public grid. Work mode depends on PV energy and user's preference. It can provide power for emergency use during the grid lost by using the energy from battery and inverter (generated from PV).In addition, the parallel function is available(off grid model).

System Diagram 1 (applies to most countires)

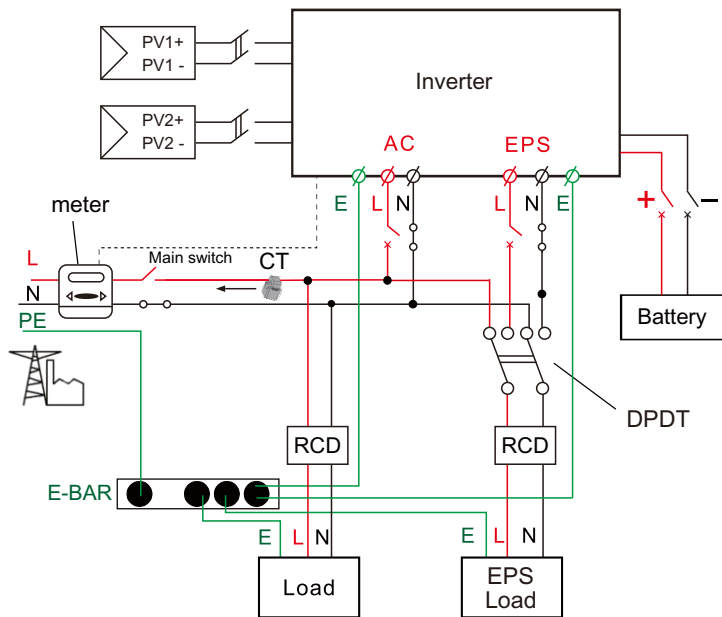

System Diagram 2 (applies to wiring rules AS/NZS_3000:2012 for Australia and New Zealand)

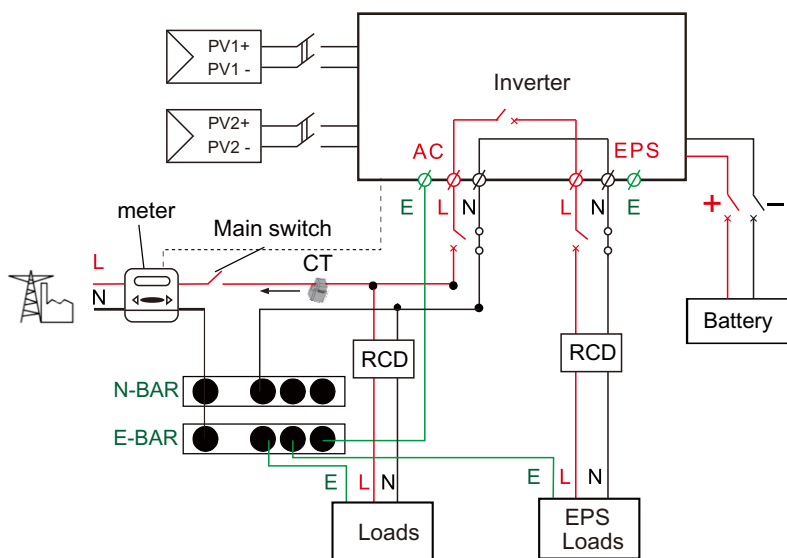

 **Note!**
The instrument and switch in the above figure are provided by users.

1.4 Work Modes

Hybrid Inverter provides multiple work modes based on different requirements.

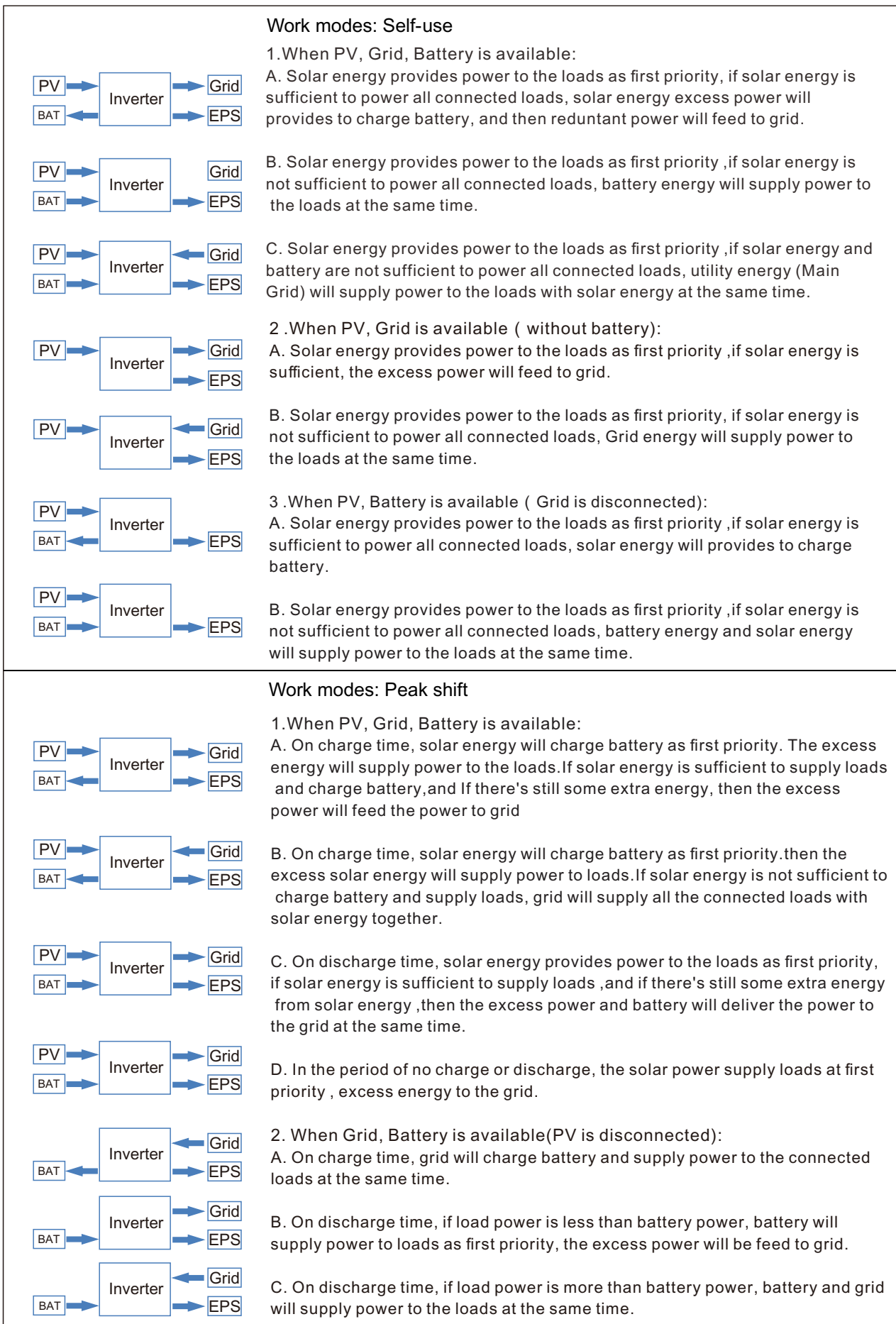

Work modes: Bat priority



1. When PV, Grid, Battery is available:

A. Solar energy will charge battery as first priority, if solar energy is excess, the excess power will supply load. If there's still some extra energy, then the excess power will feed the power to grid .



B. Solar energy will charge battery as first priority, if solar energy is excess, the excess power will supply load. If solar energy is not sufficient to charge battery and supply loads, grid will supply power to loads.



2. When Grid, Battery is available (PV is disconnected):

Grid will supply power to load and charge battery at the same time.

Note!



If set anti-Reverse function allowable, Once on the work mode of Self-use, Peak shift, battery priority, the system will not feed power to grid.

1.5 Dimension

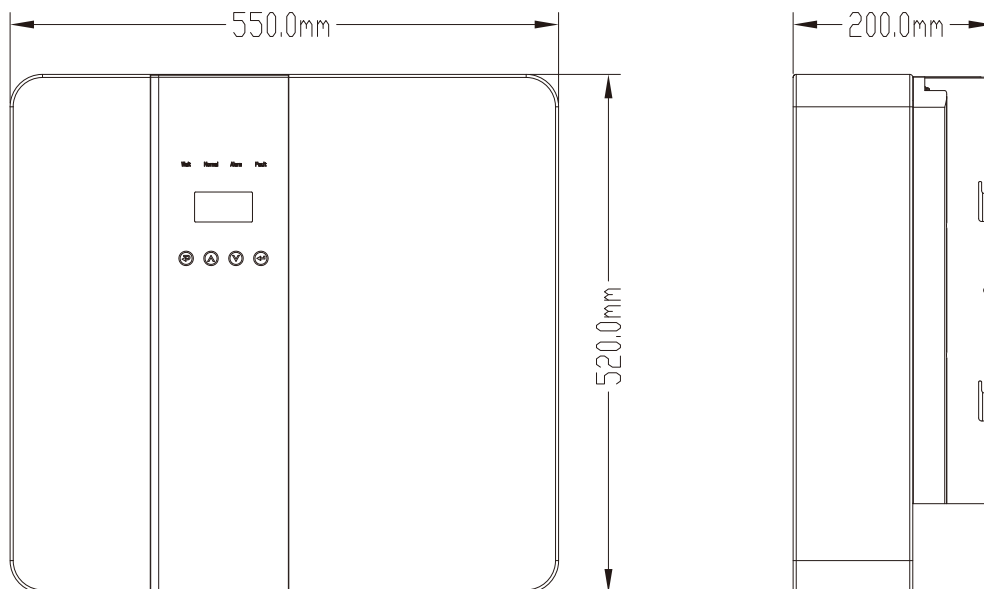

2. Interface definition and Technical Data

2.1 Interface definition

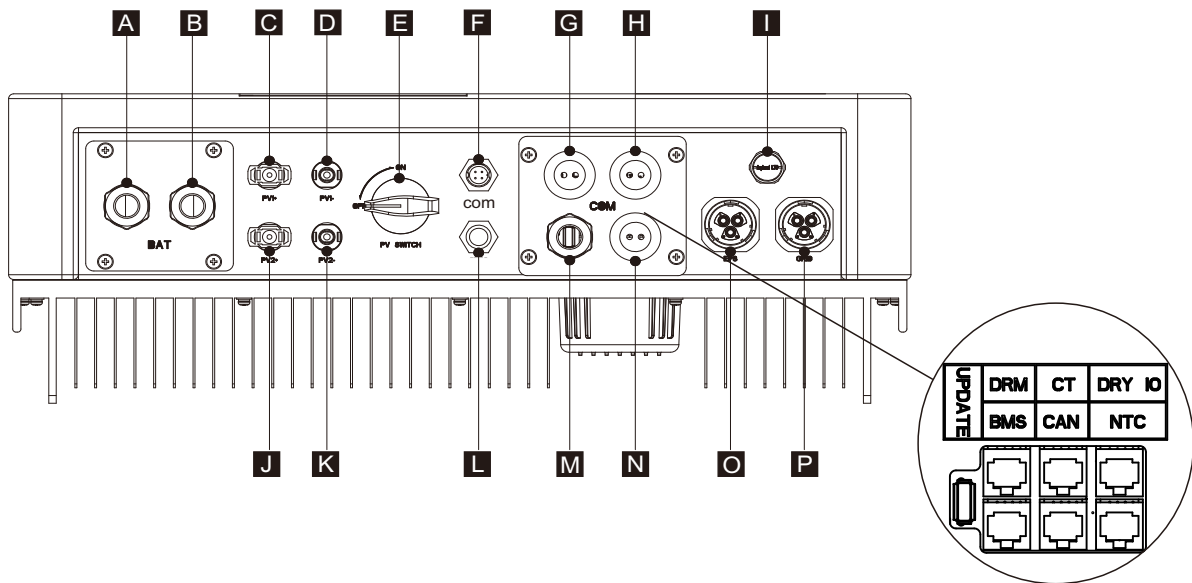

Object	Description
A/B	Battery +/Battery -
C/D	PV1+/PV1-
J/K	PV2+/PV2-
E	DC switch
F	WiFi port for external WiFi
L	Reserved port
G	DRM/BMS
H	Grid current / DRY IO
M	USB port for upgrading
N	POWER CAN /LEAD-NTC
	Pressure valve
O	EPS output
P	Grid output



Note!

- 1.The Update port: For on-premises upgrades.
- 2.The BMS port: BMS communication for lithium batteries.
- 3.The CT port: For external grid side CT to detect current size.
- 4.The DRM port, CAN port, NTC port and DRY IO port: Reserved port, temporarily unavailable

2.2 Technical Data

Model	BD3KTL-RL1	BD3K6TL-RL1	BD4KTL-RL1	BD4K6TL-RL1	BD5KTL-RL1	BD6KTL-RL1
DC input						
Max. recommended DC power [W]	4600	4600	6000	6000	7000	7000
Max. DC voltage[V]	550	550	550	550	550	550
Normal DC operating voltage[V]	360	360	360	360	360	360
MPPT voltage range [V]	125-500	125-500	125-500	125-500	125-500	125-500
MPPT voltage range@full load [V]	150-500	150-500	170-500	170-500	220-500	220-500
Max. input current [A]	14/14	14/14	14/14	14/14	14/14	14/14
Max. short circuit current [A]	17.5/17.5	17.5/17.5	17.5/17.5	17.5/17.5	17.5/17.5	17.5/17.5
Start input voltage [V]	125	125	125	125	125	125
No. of MPP trackers	2	2	2	2	2	2
Strings per MPP tracker	1	1	1	1	1	1
Max. inverter backfeed current to array	0	0	0	0	0	0
DC disconnection switch	/					
AC output						
Normal AC power[VA]	3000	3680	4000	4600	5000	6000
Max. apparent AC power[VA]	3000	3680	4000	4600	5000	6000
Rated grid voltage(range)[V]	230 (176 to 270)					
Rated grid frequency[Hz]	50/60					
Normal AC current[A]	13	16	17.4	20	21.7	26
Max.AC current[A]	13	16	17.4	20	21.7	26
Displacement power factor	0.99 leading...0.99 lagging					
Total harmonic distortion(THDI)	< 2%					
Load control	optional					
AC input						
Normal AC power[VA]	3000	3680	4000	4600	5000	6000
Rated grid voltage(range)[V]	230(176 to 270)					
Rated grid frequency[Hz]	50/60					
Normal AC current[A]	13	16	17.4	20	21.7	26
Max.AC current[A]	13	16	17.4	20	21.7	26
Displacement power factor	0.99 leading~0.99 lagging					
AC inrush current	35	35	35	35	35	35
EPS output						
EPS rated power[VA]	3000	3680	4000	4600	5000	6000
Max. EPS power[VA]	3000	3680	4000	4600	5000	6000
EPS rated voltage, Frequency	230VAC, 50/60Hz					
EPS rated current[A]	13	16	17.4	20	21.7	26
Max. EPS current[A]	13	16	17.4	20	21.7	26
Switch time[s]	<20ms					
Total harmonic distortion(THDv)	<2%					
Parallel operation	Yes					
Compatible with the generator	Yes(signal provided only)					
Battery parameter						
Battery type	Lithium battery/Lead-ACID					
Battery voltage range[V]	40-58					
Recommended battery voltage[V]	48					
Cut Off Voltage[V]	40					
Max. charging Voltag[V]	58					
Max. Protective Voltage[V]	59					
Max. charge/discharge current[A]	95/62.5	95/76.6	95/83.3	95/95.8	95/104.2	95/110
Peak charge/discharge current[A]	95/62.5	95/76.6	95/83.3	95/95.8	95/104.2	95/110
Communication interfaces	CAN/RS485/Wifi/LAN/DRM					
Reverse connect protection	Yes					
Efficiency						
MPPT efficiency	99.9%					
Euro efficiency	97%					
Max. efficiency	97.6%					
Max. Battery charge efficiency	95%					
Max. Battery discharge efficiency	95%					

Note: If the South African national grid standard is selected, the grid power is only 4.6kW!

2.3 Basic Data

Model	BD3KTL-RL1	BD4KTL-RL1	BD5KTL-RL1
	BD3K6TL-RL1	BD4K6TL-RL1	BD6KTL-RL1
Dimension [W/H/D](mm)	550*520*200		
Dimension of packing [W/H/D](mm)	665*635*330		
Net weight [kg]	25		
Gross weight [kg]	31		
Installation	modularization		
Operating temperature range[°C]	-25~+60 (derating at 45)		
Storage temperature [°C]	-25~+60		
Storage/Operation relative humidity	4%~100% (Condensing)		
Altitude [m]	<2000		
Ingress Protection	IP65(for outdoor use)		
Protective Class	I		
Night-time consumption	<3W		
Over Voltage Category	III(MAINS),II(PV,Battery)		
Pollution Degree	II		
cooling	Nautral		
Noise level	<40dB		
Inverter Topology	non-isolated		
Active anti-islanding method	Power variation		
Communication interface	CAN/RS485/Wifi/LAN/DRM		

2.4 Safety and Protection

Safety & Protection	
Over/under voltage protection	YES
DC isolation protection	YES
Monitoring ground fault protection	YES
Grid protection	YES
DC injection monitoring	YES
Back feed current monitoring	YES
Residual current detection	YES
Anti-islanding protection	YES
Over load protection	YES
Over heat protection	YES
Max. output fault current	55A
Max. output over current	28.7A

3. Installation

3.1 Check for Physical Damage

Make sure the inverter is intact during transportation. If there is any visible damage, such as cracks, please contact your dealer immediately.

3.2 Packing List

Open the package and take out the product, please check the accessories first. The packing list shown as below.

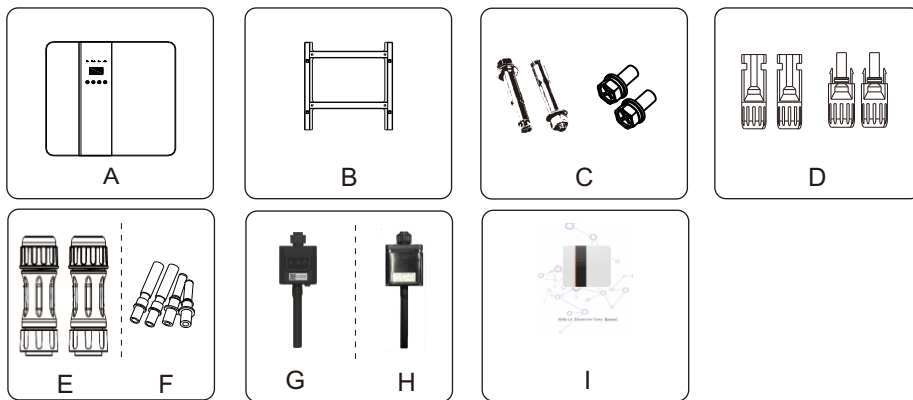

Object	Description
A	Inverter
B	Bracket
C	Expansion screws and pan-head screws
D	PV connectors (2*positive, 2*negative)
E	AC terminals
F	PV pin connectors (2*positive, 2*negative)
G	Wi fimodule (optional)
H	GPRS module (optional)
I	User manual

3.3 Tools required for installation.

Installation tools : crimping pliers for binding post and RJ 45, screwdriver, manual wrench etc.



3.4 Mounting

➤ Space Requirement

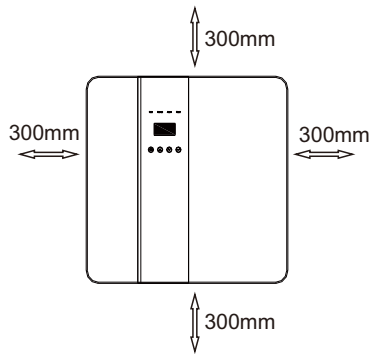
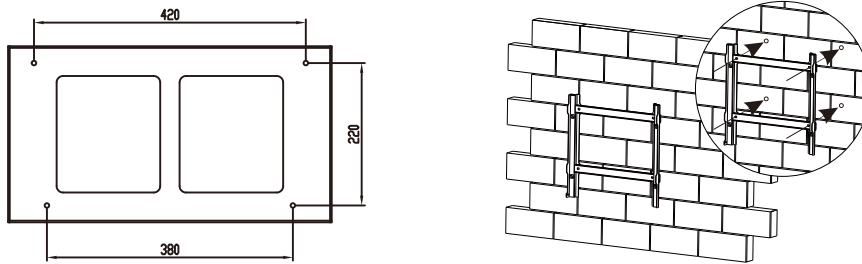

Table Available Space Size

Position	Min.size
Left	300mm
Right	300mm
Top	300mm
Bottom	300mm
Front	300mm

Step 1: Screw the wall bracket on the wall

- 1.1 Place the bracket on the wall and mark down the position of the 4 holes.
- 1.2 Drill holes with driller, make sure the holes are deep enough (at least 60mm) to support the inverter.
- 1.3 Install the expansion tubes in the holes, and tighten them. Then install the wall bracket with the expansion screws.



Step 1

Step 2: Place the inverter on the wall mounted bracket by holding the handle on the side.

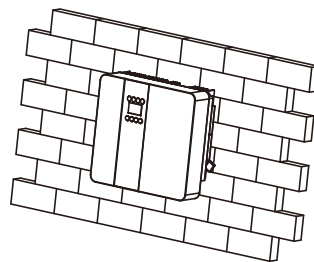

Step 2

Step 3: Tighten the fixing screws on both sides of the inverter.

Step 4: If necessary, customer can install an anti-theft lock on the left-bottom of the inverter.

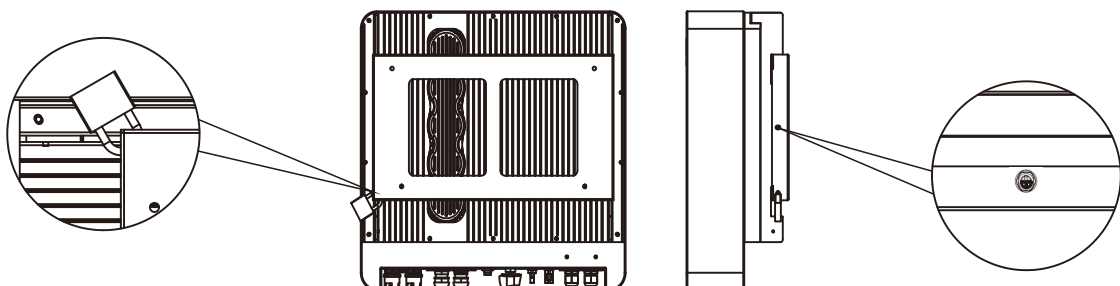

Step 3, Step 4

4. Electrical Connection

- Electrical connection diagram

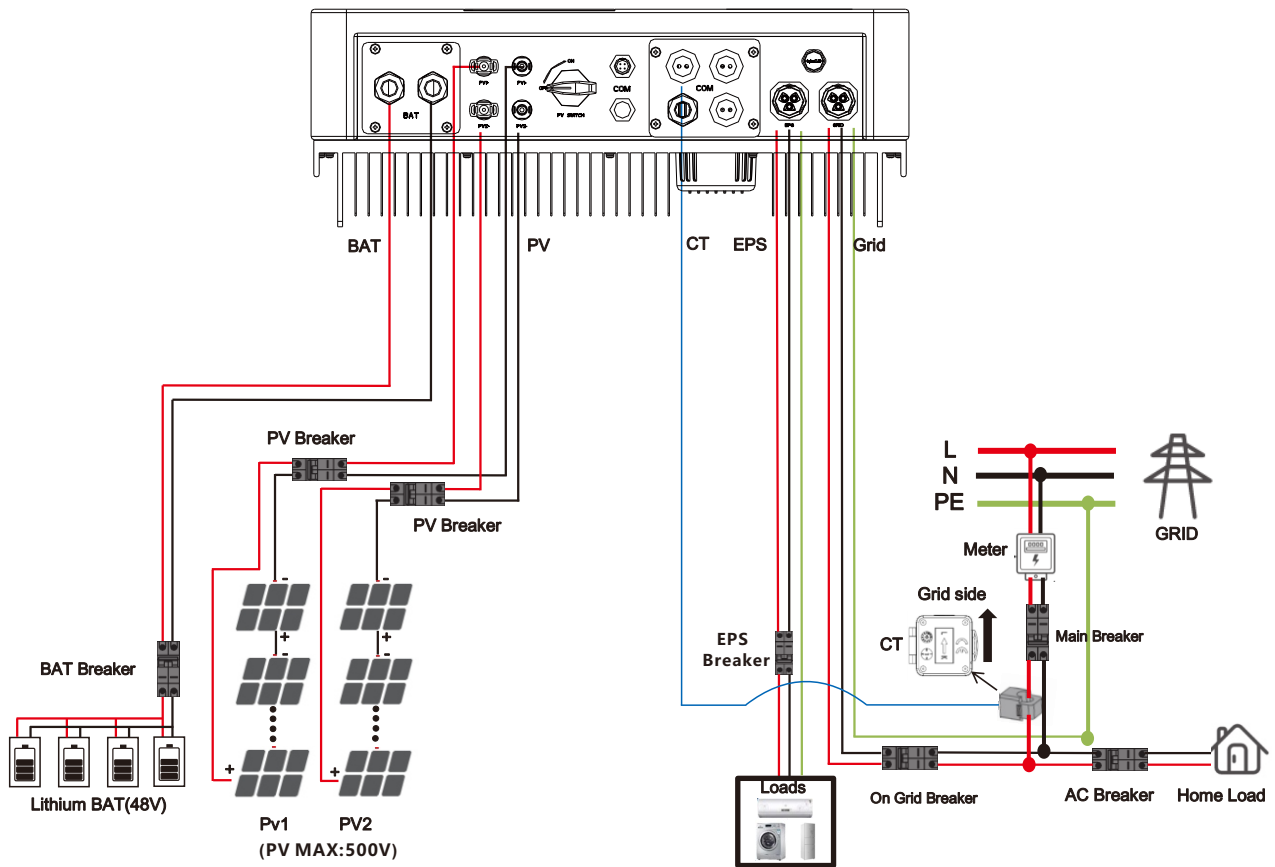

4.1 Grid connection and EPS connection

Hybrid inverter are designed for single phase grid. Voltage is 220/230/240V, frequency is 50/60Hz.

Other technical requests should comply with the requirement of the local public grid.

Table 1 Cable and Micro-breaker recommended

Model	BD3KTL-RL1	BD3K6TL-RL1	BD4KTL-RL1	BD4K6TL-RL1	BD5KTL-RL1	BD6KTL-RL1
Cable	4-5 mm ²			5-6mm ²		
Micro-breaker	20A			32A		

Micro-breaker should be installed between inverter and grid, any load should not be connected with inverter directly.

Step1. Check the grid voltage.

1.1 Check the grid voltage and compare with the permissive voltage range (Please refer to technical data).

1.2 Disconnect the circuit board from all the phases and secure against re-connection.

Step2. Remove the waterproof lid from the grid port on the inverter.

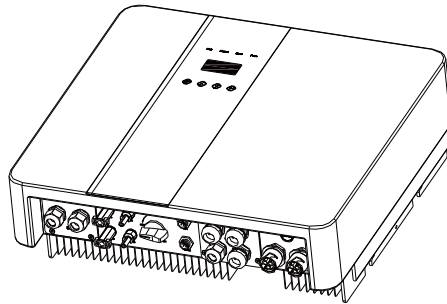

Step3. Make AC and EPS wires.

3.1 Choose the appropriate wire(Cable size: refer to Table 1).

3.2 Reserve about 60mm of conductor material sectional area and remove 10mm of insulation from the end of wire.

3.3 Separate the docking screw cap of the AC terminal from the housing portion and insert stripped wires into AC terminal and tighten the screws with a hexagonal wrench.

3.4 Tighten the docking screw cap and housing portion of the AC terminal.

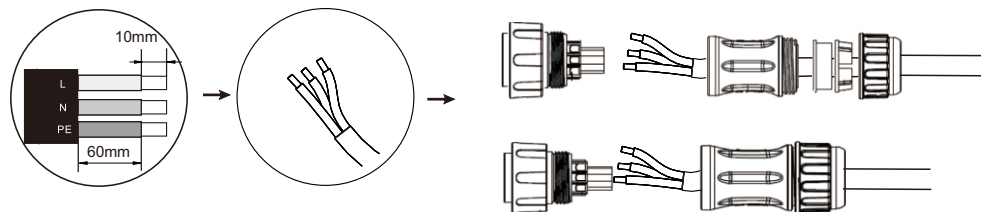

Step4. Connect the AC connector to the GRID port of the inverter and tighten the screw cap .

Connect the LOAD connector to the EPS port of the inverter and tighten the screw cap .

Note: Connect the AC connector to the GRID into grid interface.

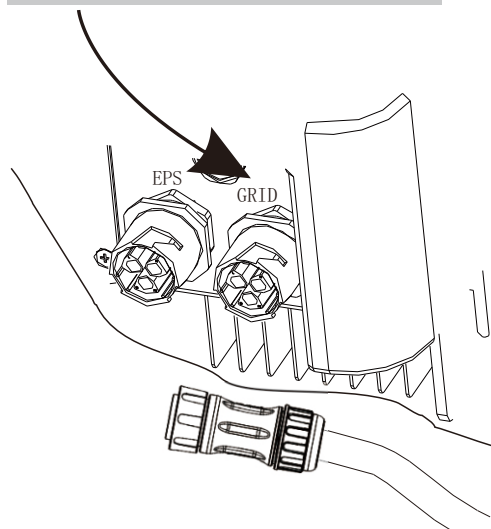

4.2 PV connection

Hybrid Inverter can be connected in series with 2-strings PV modules for 3KW,3.6KW,4KW,4.6KW, 5KW and 6KW.

Select PV modules with excellent function and reliable quality. Open-circuit voltage of module arrays connected in series should be <Max. DC input voltage;operating voltage should be conformed to MPPT voltage range.

Max.DC Voltage Limitation

Model	BD3KTL-RL1	BD3K6TL-RL1	BD4KTL-RL1	BD4K6TL-RL1	BD5KTL-RL1	BD6KTL-RL1
Max. DC Voltage (V)	550					
MPPT Voltage Range(V)	125-500					



Warning!

- PV module voltage is very high, which already achieve dangerous voltage range, please comply with electric safety rules when connecting.
- Please do not make PV positive or negative ground!

Connection Steps:

Step1. Checking PV module to ensure PV is in open circuit state and ensure the PV+ and PV- ports of the PV string are correct.

Step2. Separating the DC connector.

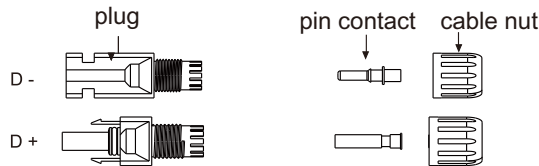

Step3. Wiring

3.1 Choose the 12 AWG wire to connect with the cold-pressed terminal.

3.2 Remove 10mm of insulation from the end of wire.

3.3 Insert the insulation into pin contact and use crimping plier to clamp it.

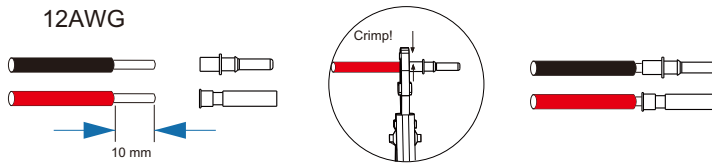

Step4. Insert pin contact through the cable nut to assemble into back of the male or female plug. When you feel or heard a “click” sound the pin contact assembly is seated correctly.

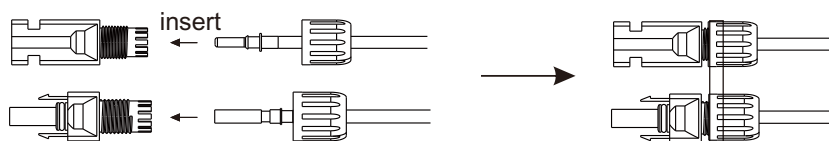

Step5. Plug the PV connector into the corresponding PV connector on inverter.

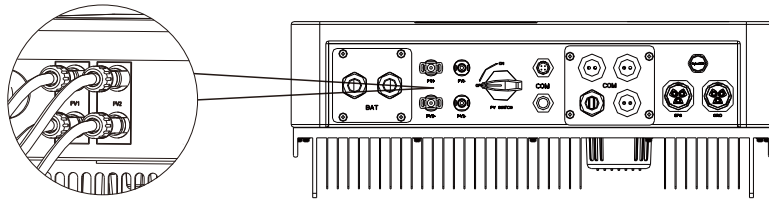

4.3 Battery Connection

➤ Note

1. Before choosing battery, please note the maximum voltage of battery can not exceed 59V and the rated voltage of battery can not exceed 48V, and the battery communication should be compatible with Hybrid inverter.
2. Before connecting to battery, please install a nonpolarized DC(125A) breaker to make sure inverter can be securely disconnected during maintenance.
3. The connecting cable between the battery and the inverter shall be at least 4AWG.
4. The battery communication can only work when the battery BMS is compatible with the inverter.
5. To replace the battery, you need to turn off all switches and unplug the system communication line.
6. All the above wiring and operations must be carried out after the whole machine is powered down, and all of them need professional personnel to complete

➤ Power Connection Steps:

Step1. Choose the 4AWG wire and strip the cable to 15mm.

Step2. Select two O-terminals with an aperture of M6.

Step3. Insert the stripping line into the O-terminal and clamp it with a crimping clamp.

Step1,2,3.



Step4. Remove waterproof cover plate.

Step5. Disassemble the waterproof connector and pass the cable through the waterproof connector.

Step4.

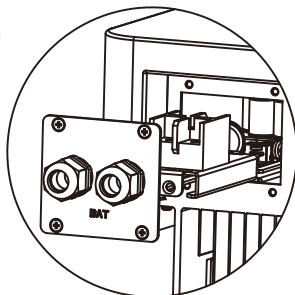

Step5.

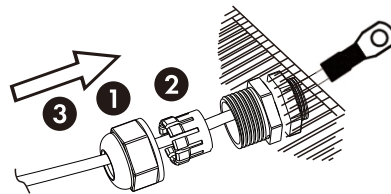

- Step6. Connect the cable to the terminal of the inverter .
 Step7. Assemble waterproof connectors and waterproof covers plate.

Step6 , 7

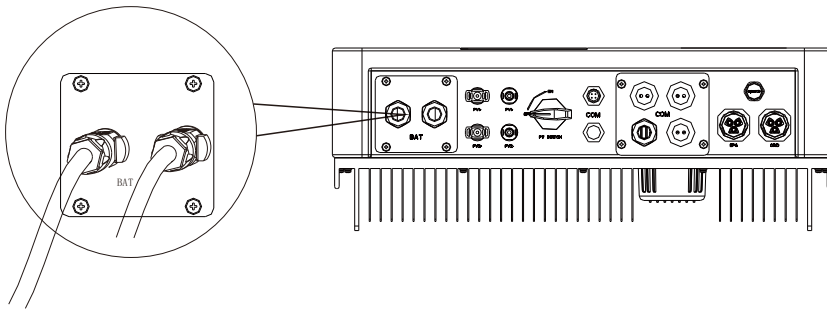

Note !
 Positive and negative lines are not allowed to reverse.
 The positive pole on the left and the negative pole on the right.

4.4 Communication interface definition

➤ BMS PIN Definition

Communication interface between inverter and battery is RS485 or CAN with a RJ45 connector.
 The wiring sequence of the crystal head conforms to the 568B standard: orange white, orange, green white, blue, blue white, green, brown white and brown.

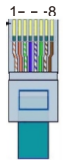

	PIN	1	2	3	4	5	6	7	8
CAN	Definition	X	X	X	BMS_CANH	BMS_CANL	X	X	X
Rs485	Definition	X	X	X	X	X	GND	BMS_485A	BMS_485B

➤ DRY_IO (RJ45 PIN) Definition

Reserved dry contact interface of the inverter.

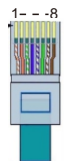

	1	2	3	4	5	6	7	8
COM1	NO 1	NC 1	DI 1	DI 2	COM2	NO 2	NC 2	

➤ DRM Connection

DRM is provided to support several demand response modes by emitting control signals as below.

Note: Only PIN6(DRM0) is available now, and other PIN functions are being developed.

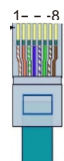

	1	2	3	4	5	6	7	8
DRM1/5	DRM2/6	DRM3/7	DRM4/8	+5V	DRM0	GND	GND	

4.5 WiFi And GPRS Connection(optional)

Inverter provides a WiFi port which can collect data from inverter and transmit it to monitoring-website by WiFi.

Step1. Plug Wifi into “COM” port at the bottom of the inverter.

Step2. Build the connection between the inverter and router.

Step3. Create a user account online.(Please check the WiFi user manual for more details).

➤ Diagram

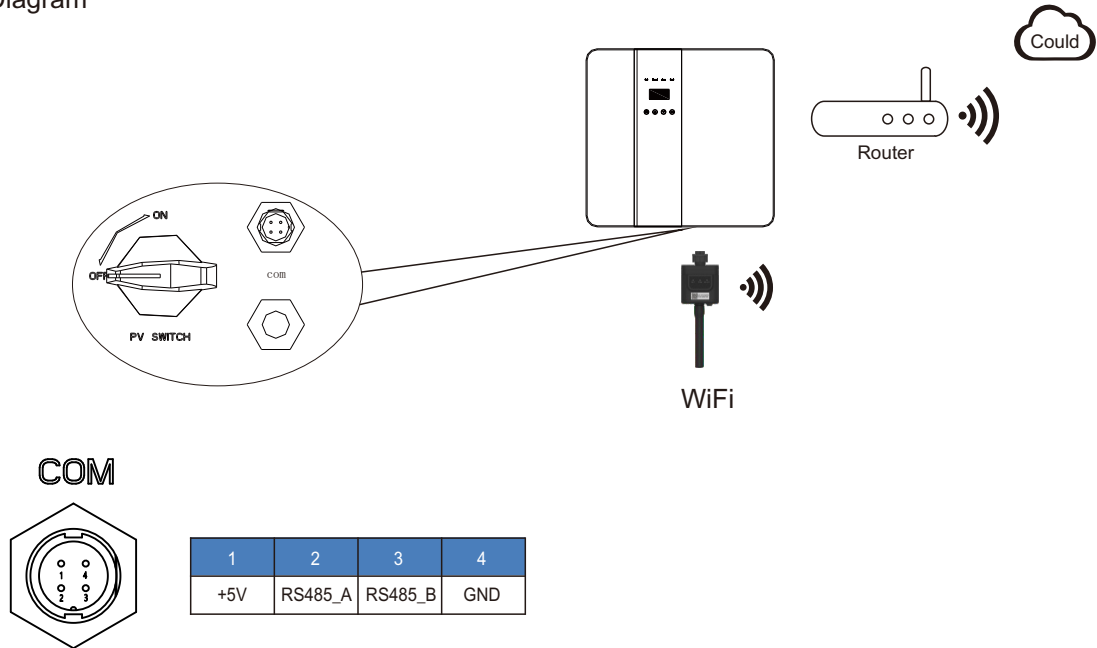

➤ GPRS Connection :

GPRS connection interface is consistent with WIFI interface, Please refer to the GPRS user manual for detailed connection steps.

➤ Diagram

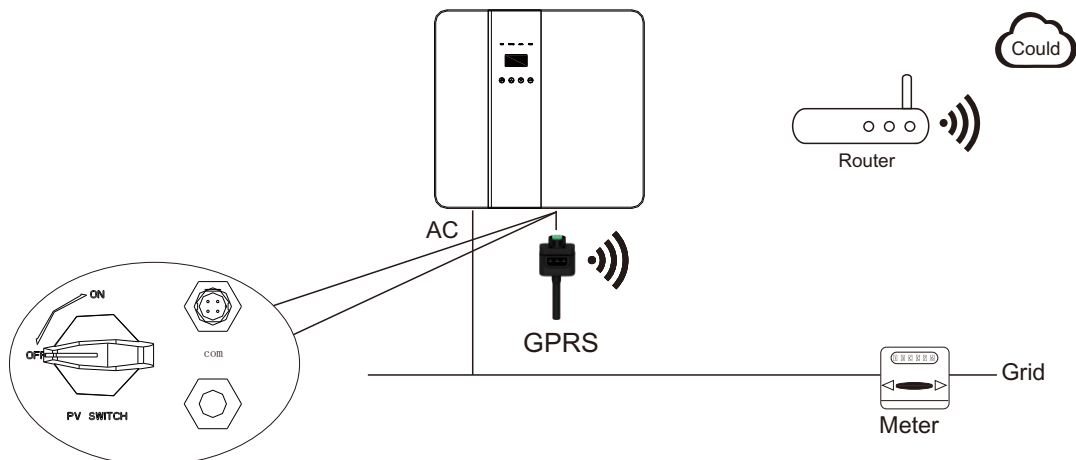

5. LCD Interface and Setting

5.1 Control Panel

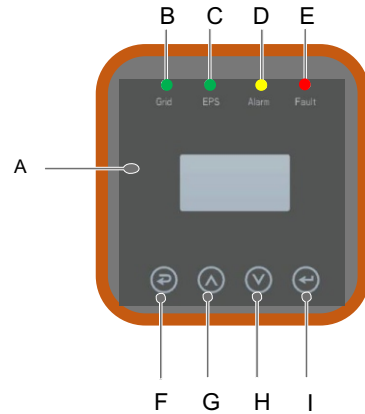

Object	Name	Description
A	LCD Screen	Display the information of the inverter.
B	Indicator LED	lit in green: The inverter is in grid mode. Off: The inverter is in not in grid mode.
C		lit in green: The inverter is in off-grid mode. Off: The inverter is in not in off-grid mode.
D		lit in Yellow: The inverter is in Warning . Off: The inverter has no Inverter Warning
E		lit in red: The inverter is in fault status. Off: The inverter has no errors.
F	Function Button	Esc: Return from current interface or function.
G		Up: Move cursor to upside or increase value.
H		Down: Move cursor to downside or decrease value.
I		Enter: Confirm the selection.

5.2 Instructions for LED Indicator

	Grid (Green)	EPS (Green)	Alarm (Yellow)	Fault (Red)
Initialization	off	off	off	off
Stand-by	off	off	off	off
Grid mode	on	off	off	off
Off-Grid	off	on	off	off
Bypass of mains	off	on	on	off
Fault	off	off	off	on

5.3 Instructions for the use of three modes

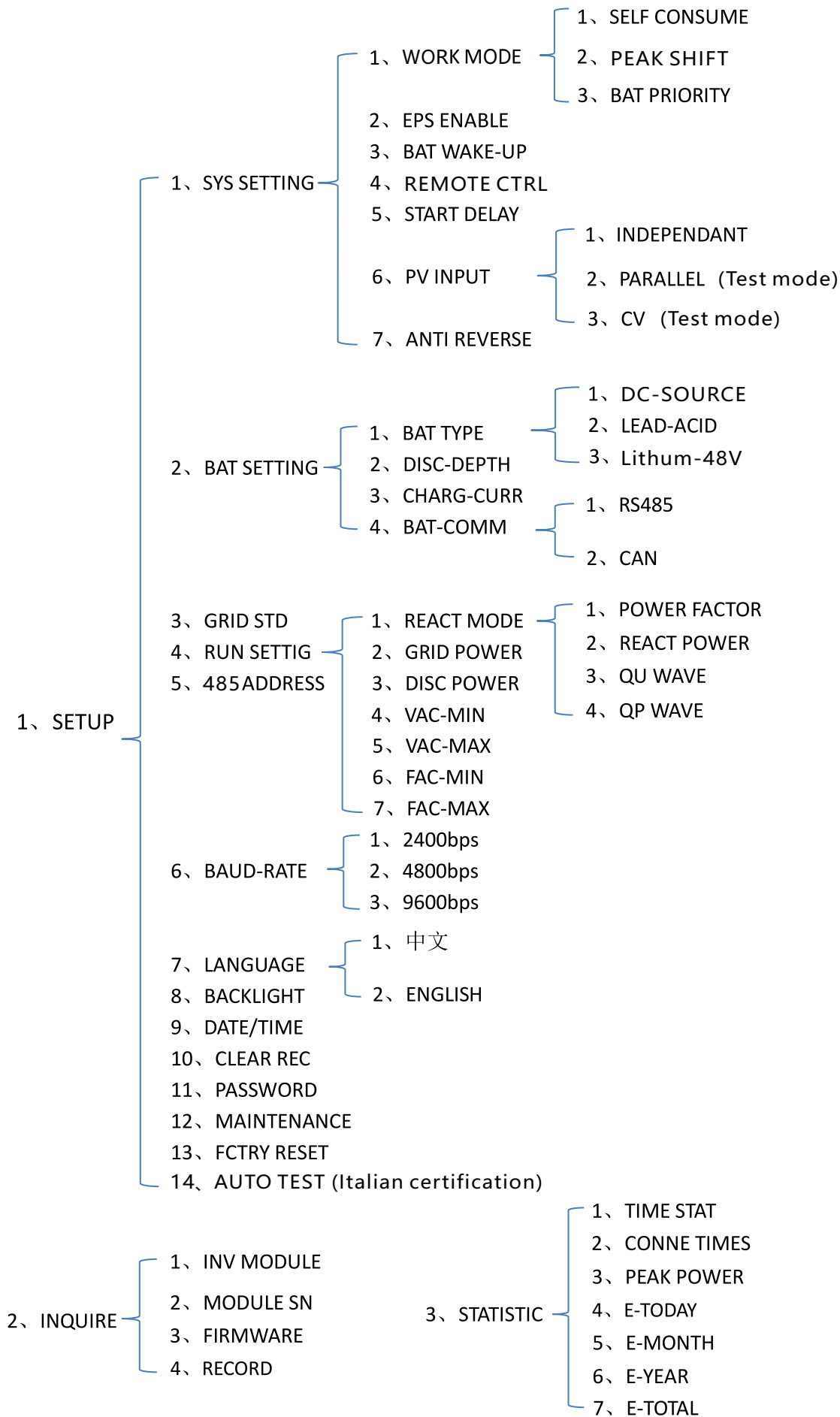

For example, Before selecting the mode, you can set it up according to the local power grid, PV input mode and battery type.

Power grid :

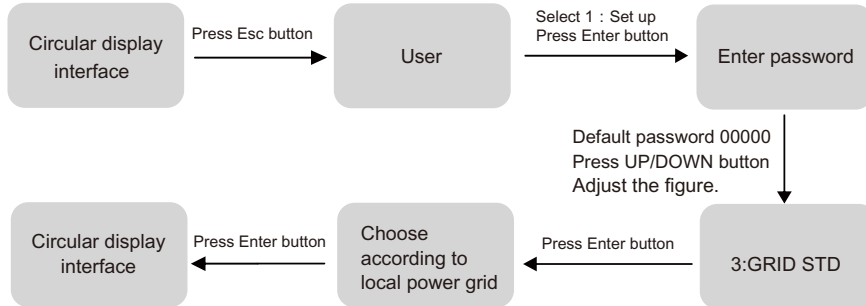

PVinput mode :

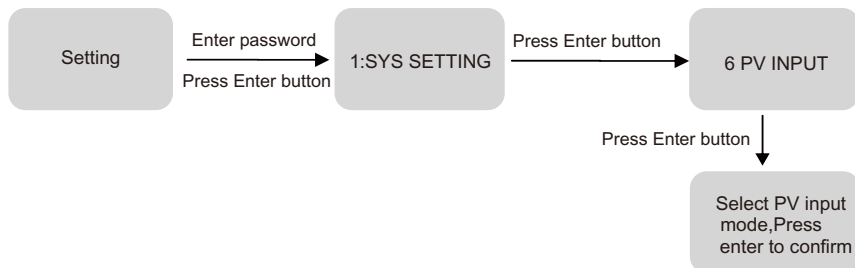

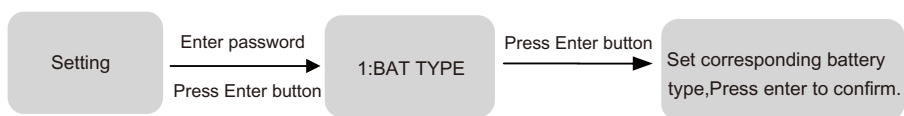

Battery parameters :



5.4 LCD Interface

5.4.1 Error information

Interface	Description
ERROR NO.  02:BatDisconnect 27:BMS Comm.fail	Numbers represent error codes and text is error information. Refer to Chapter 9 for specific contents. NOTE: When there is a lock mark  in the upper right corner of the screen, you cannot turn the page, you need to press Enter to unlock it first.

5.4.2 System setting

Interface	Description
SYSTEM1 STATE : SELF CSM GRID : US-CA PV I/P : PARALL	State: Setting of the whole machine working mode. Including: SELF CONSUME, PEAK SHIFT and BAT PRIORITY. Refer to Chapter 3.3 for specific contents. Grid standard: Displays the grid standard actually set. PV input mode: The display value is the setting value of PV input type. Including: INDEPENDANT, PARALLEL, CV.

5.4.3 System setting2

Interface	Description
SYSTEM2 BMS Com: CAN Anti Reve : DISA DOD: 80%	BMS Com: Battery Management System communication mode. Including: CAN, RS485. Anti Reve: Displays Whether Inverter isn't allowed to generate electricity to the Grid. Including: DISABLE,ENABLE DOD: Depth of battery discharge.

5.4.4 System setting3

Interface	Description
SYSTEM3 EPS ENABLE: ENAB	EPS ENABLE: When the Grid and PV are powered off, Enable the battery to supply power to the load, default option is enable. See Chapter 8.2.4.2 for setting details

5.4.5 PV1 Input display interface

Interface	Description
PV1 INPUT VOLT: 300V CURR: 10.00A POWER: 3000W	PV1 input real-time voltage, current and power.

5.4.6 PV2 Input display interface

Interface	Description								
<table border="1"> <tr> <td colspan="2">PV2 INPUT</td> </tr> <tr> <td>VOLT:</td> <td>300V</td> </tr> <tr> <td>CURR:</td> <td>10.00A</td> </tr> <tr> <td>POWER:</td> <td>3000W</td> </tr> </table>	PV2 INPUT		VOLT:	300V	CURR:	10.00A	POWER:	3000W	PV2 input real-time voltage, current and power.
PV2 INPUT									
VOLT:	300V								
CURR:	10.00A								
POWER:	3000W								

5.4.7 DC Voltage interface

Interface	Description						
<table border="1"> <tr> <td colspan="2">DC VOLTAGE</td> </tr> <tr> <td>BUS:</td> <td>384V</td> </tr> <tr> <td>LeakCurr:</td> <td>0mA</td> </tr> </table>	DC VOLTAGE		BUS:	384V	LeakCurr:	0mA	BUS: Real-time voltage of bus capacitor of the machine. LeakCurr: Real-time leak current of the machine.
DC VOLTAGE							
BUS:	384V						
LeakCurr:	0mA						

5.4.8 Battery interface

Interface	Description								
<table border="1"> <tr> <td colspan="2">BATTERY</td> </tr> <tr> <td>VOLT:</td> <td>300V</td> </tr> <tr> <td>CURR:</td> <td>10.00A</td> </tr> <tr> <td>STA:</td> <td>C D F</td> </tr> </table>	BATTERY		VOLT:	300V	CURR:	10.00A	STA:	C D F	Battery real-time voltage, current. STA: Battery status. C: Charge. D: Discharge. F: Full charge. Battery status depends on BMS instructions.
BATTERY									
VOLT:	300V								
CURR:	10.00A								
STA:	C D F								

5.4.9 Battery current interface

Interface	Description								
<table border="1"> <tr> <td colspan="2">BATTERY INFO</td> </tr> <tr> <td>TYPE:</td> <td>Lithum</td> </tr> <tr> <td>TEMP:</td> <td>26°C</td> </tr> <tr> <td>SOC:</td> <td>30%</td> </tr> </table>	BATTERY INFO		TYPE:	Lithum	TEMP:	26°C	SOC:	30%	TYPE: Battery type:(lead acid, lithium battery) TEMP: Battery temperature. SOC: Percentage of battery surplus capacity
BATTERY INFO									
TYPE:	Lithum								
TEMP:	26°C								
SOC:	30%								

5.4.10 Battery current interface

Interface	Description								
<table border="1"> <tr> <td colspan="2">BMS PRMETER</td> </tr> <tr> <td>CHAR VOL:</td> <td>0.0V</td> </tr> <tr> <td>CHARGE:</td> <td>50A</td> </tr> <tr> <td>DISCHA:</td> <td>50A</td> </tr> </table>	BMS PRMETER		CHAR VOL:	0.0V	CHARGE:	50A	DISCHA:	50A	CHAR VOL: Battery charging voltage. CHARGE: Battery charging current. DISCHA: Battery discharging current.
BMS PRMETER									
CHAR VOL:	0.0V								
CHARGE:	50A								
DISCHA:	50A								

5.4.11 Grid-connected

Interface	Description								
<table border="1"> <tr> <td colspan="2">GRID</td> </tr> <tr> <td>VOLT:</td> <td>0.0V</td> </tr> <tr> <td>CURR:</td> <td>0.00A</td> </tr> <tr> <td>FREQ:</td> <td>0.00Hz</td> </tr> </table>	GRID		VOLT:	0.0V	CURR:	0.00A	FREQ:	0.00Hz	VOLT: Grid real-time voltage. CURR: CT real-time current. FREQ: Grid real-time frequency.
GRID									
VOLT:	0.0V								
CURR:	0.00A								
FREQ:	0.00Hz								

5.4.12 INV

Interface	Description								
<table border="1"> <tr> <td colspan="2">INV</td> </tr> <tr> <td>VOLT:</td> <td>0.0V</td> </tr> <tr> <td>CURR:</td> <td>0.00A</td> </tr> <tr> <td>FREQ:</td> <td>0.00Hz</td> </tr> </table>	INV		VOLT:	0.0V	CURR:	0.00A	FREQ:	0.00Hz	VOLT: INV real-time voltage. CURR: INV real-time current. FREQ: INV real-time frequency.
INV									
VOLT:	0.0V								
CURR:	0.00A								
FREQ:	0.00Hz								

5.4.13 LOAD

Interface	Description								
<table border="1"> <tr> <td colspan="2">LOAD</td> </tr> <tr> <td>VOLT:</td> <td>0.0V</td> </tr> <tr> <td>CURR:</td> <td>0.00A</td> </tr> <tr> <td>PERCENT:</td> <td>0%</td> </tr> </table>	LOAD		VOLT:	0.0V	CURR:	0.00A	PERCENT:	0%	VOLT: LOAD real-time voltage. CURR: LOAD real-time current. PERCENT: LOAD real-time percentage.
LOAD									
VOLT:	0.0V								
CURR:	0.00A								
PERCENT:	0%								

5.4.14 POWER

Interface	Description						
<table border="1"> <tr> <td colspan="2">POWER</td> </tr> <tr> <td>INV:</td> <td>0.0W</td> </tr> <tr> <td>GRID:</td> <td>0.0W</td> </tr> </table>	POWER		INV:	0.0W	GRID:	0.0W	INV: INV power. GRID: Grid power.
POWER							
INV:	0.0W						
GRID:	0.0W						

5.4.15 POWER

Interface	Description								
<table border="1"> <tr> <td colspan="2">POWER</td> </tr> <tr> <td>PV I/P:</td> <td>0W</td> </tr> <tr> <td>LOAD:</td> <td>0W</td> </tr> <tr> <td>BAT:</td> <td>0W</td> </tr> </table>	POWER		PV I/P:	0W	LOAD:	0W	BAT:	0W	PV I/P: PV power. LOAD: LOAD power. BAT: BAT power.
POWER									
PV I/P:	0W								
LOAD:	0W								
BAT:	0W								

5.4.16 Temperature

Interface	Description								
<table border="1"> <tr> <td colspan="2" data-bbox="279 253 550 291">TEMPERATURE</td> </tr> <tr> <td data-bbox="279 297 454 336">INVER:</td> <td data-bbox="454 297 550 336">0°C</td> </tr> <tr> <td data-bbox="279 342 454 380">DCDC:</td> <td data-bbox="454 342 550 380">0°C</td> </tr> <tr> <td data-bbox="279 387 454 425">INSIDE:</td> <td data-bbox="454 387 550 425">0°C</td> </tr> </table>	TEMPERATURE		INVER:	0°C	DCDC:	0°C	INSIDE:	0°C	INVER: INV Temperature. DCDC: DCDC Temperature. INSIDE: Internal ambient temperature of the machine.
TEMPERATURE									
INVER:	0°C								
DCDC:	0°C								
INSIDE:	0°C								

5.4.17 State

Interface	Description								
<table border="1"> <tr> <td colspan="2" data-bbox="279 674 550 712">STATE</td> </tr> <tr> <td data-bbox="279 719 454 757">SYS:</td> <td data-bbox="454 719 550 757">STANDBY</td> </tr> <tr> <td data-bbox="279 763 454 801">INV:</td> <td data-bbox="454 763 550 801">STANDBY</td> </tr> <tr> <td data-bbox="279 808 454 846">DCDC:</td> <td data-bbox="454 808 550 846">STANDBY</td> </tr> </table>	STATE		SYS:	STANDBY	INV:	STANDBY	DCDC:	STANDBY	System information: Display complete machine status information, Including: Initialization, Standby, PV grid connection, Grid connection of battery, Hybrid power supply, etc. INV: Displays the inverter status information. DCDC: Displays charging and discharging status information
STATE									
SYS:	STANDBY								
INV:	STANDBY								
DCDC:	STANDBY								

5.5 Settings

5.5.1 State

Interface	Description
USER → 1:SETUP 2:INQUIRE 3:STATISTIC	SETUP: Press Enter to user settings interface. INQUIRE: Query machine model, serial number, software version. STATISTIC: View machine run statistics.

5.5.2 SET Password

Interface	Description
PASSWORD INPUT: XXXXX	Enter the password required for setting. The default password is "00000". Press the Up or Down keys to adjust the number, press the Enter key to move the cursor forward, and press the Esc key move the cursor backward.

5.5.3 Setup

Interface	Description
SETUP → 1:SYS SETTING 2:BAT SETTING 3:GRID STD 4:RUN SETTING 5:485 ADDRESS 6:BAUD RATE 7:LANGUAGE 8:BACKLIGHT 9:DATE/TIME 10:CLEAR REC 11:PASSWORD 12:MAINTENANCE 13:FCTRY RESET	This interface is used for various information inquiry options. Press the Up/Down button to make the corresponding selection. Press Enter button to enter the selected menu. Press ESC button return to the user interface. There are 13 options in total.

5.5.4 System setting

5.5.4.1 System setting

Interface	Description
SYS SETTING → 1: WORK MODE 2: EPS ENABLE 3: BAT WAKE-UP 4: REMOTE CTRL 5: START DELAY 6: PV INPUT 7: Anti Reverse	This interface is used to access system information. Press Up/Down button to move corresponding options. Press Enter to enter the selected menu. Press ESC button to return to the setting interface. There are 7 options in total.

5.5.4.1.1 Work mode

Interface	Description
WORK MODE → 1:SELFCONSUME 2:PEAK SHIFT 3:BAT PRIORITY	This interface is used to select the working mode. Press ESC button return to setting interface. (Refer to 3.3)

5.5.4.1.2 Peak shift work time

Interface	Description
WORK MODE 1:SELFCONSUME → 2:PEAK SHIFT 3:BAT PRIORITY	This interface is used to select the working mode. Press ESC button return to setting interface. (Refer to 3.3). Select the peak clipping and valley filling mode, you also need to set the charge and discharge time
WORKTIME → 1:TIME 1 2:TIME 2 3:TIME 3	It's allowed to set Three charging and discharging periods. When setting the time, ensure that the time of the inverter is the local time. Press Enter to enter the next menu.
CHAG START1 00:00 CHARGE END100:02 DISC START1 00:03 DISCHA END1 23:59	This interface is used to adjust the time of peak load shifting. Press Up/Down button to move the corresponding options. Press Enter to enter the selected menu. Press Esc button to return to the working mode interface.

5.5.4.2 EPS enable

Interface	Description
<div style="border: 1px solid black; padding: 5px;"> EPS ENABLE 1:DISABLE → 2:ENABLE </div>	When the Grid and PV are powered off, Enable the battery to supply power to the load, default option is enable.

5.5.4.3 Battery wake-up

Interface	Description
<div style="border: 1px solid black; padding: 5px;"> WAKE-UP EN → 1:DISABLE 2:ENABLE </div>	When the battery is low and the battery relay has been disconnected, the inverter will send instructions to the battery forcibly sucking relay by BMS, and the inverter will charge. The default option is disabled. (Partial battery support)

5.5.4.4 REMOTE CTRL

Interface	Description
<div style="border: 1px solid black; padding: 5px;"> REMOTE CTRL → 1:DISABLE 2:ENABLE </div>	Remote control the inverter on or off. (Subsequent support...) The default option is disabled.

5.5.4.5 START DELAY

Interface	Description
<div style="border: 1px solid black; padding: 5px;"> START-UP DELAY INPUT: 60 UNIT: SEC </div>	The input value ranges from 20 to 300, which varies with different standards.

5.5.4.6 PV INPUT MODE

Interface	Description
<div style="border: 1px solid black; padding: 5px;"> INPUT MODE → 1.INDEPENDENT 2.PARALLEL 3.CV </div>	Setup of PV Input mode. The factory setting by default is Independent, When parallel input is set to be stand-alone mode, PV power will be imbalanced.

5.5.4.7 Anti Reverse

Interface	Description
Anti Reverse → 1.DISABLE 2.ENABLE	Anti Reverse: Whether Inverter isn't allowed to generate electricity to the Grid. The default option is disabled. It's means inverter allowed to generate electricity to the Grid

5.5.5 BAT SETTING

5.5.5.1 BAT SETTING

Interface	Description
BAT SETTING → 1.BAT TYPE 2.DISC-DEPTH 3.CHARG-CURR 4.BAT-COMM	This interface is used to select battery parameters. Press Up/Down button to move corresponding options; Press Enter button to enter the selected menu; Press ESC button to return to setting interface.

5.5.5.1.1 BAT TYPE

Interface	Description
BAT TYPE 1.DC-SOURCE → 2.LEAD-ACID 3.Lithum	This interface is used to select battery type. Press Up/Down button to move corresponding options; Press Enter button to enter the selected menu. Select the LEAD-ACID enter button to enter LEAD-ACID interface;

5.5.5.1.1.1 Lead-acid battery parameter

Interface	Description
LEAD-ACID → 1.CHARG-VOLT 2.BAT END VOLT 3:BAT OVP 4:BAT CAP	This interface is used to select LEAD-ACID battery parameter. Press Up/Down button to move corresponding options; Press Enter button to enter the selected menu;
CHARGE VOLT INPUT: 135.0 UNIT: V	This interface is used to set the lead acid battery charging voltage.

Interface	Description
BAT END VOLT INPUT: 108.0 UNIT: V	This interface is used to set the lead acid battery discharging voltage. This interface is used to set the lead acid battery Charge protection voltage. This interface is used to set the lead acid Battery capacity.
BAT OVP INPUT: 141.0 UNIT: V	
BAT CAP INPUT: 0450 UNIT: AH	

5.5.5.2 BAT-COMM

Interface	Description
BAT-COMM 1.RS485 →2.CAN	This interface is used to select battery communication. Press Up/Down button to move corresponding options; Press Enter button to enter the selected menu. The default option is CAN.

5.5.6 Grid standard

5.5.6.1 Grid std

Interface	Description
GRID STD 1.AU 2.AU-W 3.NZ 4.UK 5.VDE 6.KR 7.PHI 8.CN →9.US-CA 10.JP 11.CUSTOM	This interface is used to select Grid standard. Press Up/Down button to move corresponding options; Press Enter button to enter the selected menu. 1:AU--(Australia) 2:AU-W--(Western Australia) 3:NZ-- New Zealand 4: UK--United Kingdom 5:VDE--Germany 6:KR--Korea 7:PHI--Philippines 8:CN--China 9:US-CA--America 10:JP--Japan 11:CUSTOM--User defined

5.5.7 RUN SETTING

5.5.7.1 RUN SETTING

Interface	Description
<div style="border: 1px solid black; padding: 5px;"> RUN SETTING 1.REACT MODE → 2.GRID POWER 3.DISC POWER 4.PV POWER 5.VAC-MIN 6.VAC-MAX 7.FAC-MIN 8.FAC-MAX 9.ACTIVE REP. </div>	<p>This interface is used to select run setting. Press Up/Down button to move corresponding options; Press Enter button to enter the selected menu.</p>

5.5.7.2 REACT MODE

Interface	Description
<div style="border: 1px solid black; padding: 5px;"> RUN SETTING → 1.REACT MODE 2.GRID POWER 3.DISC POWER </div>	<p>This interface is used to select react mode. Press Up/Down button to move corresponding options; Press Enter button to enter the selected menu.</p>
<div style="border: 1px solid black; padding: 5px;"> REACT MODE → 1.POWER FACTOR 2.REACT POWER 3.QU WAVE 4.QP WAVE </div>	
<div style="border: 1px solid black; padding: 5px;"> POWER FACTOR INPUT: C1.00 </div>	<p>The input value should range between L0.80 and L0.99 or C0.8 and C1.00.</p>
<div style="border: 1px solid black; padding: 5px;"> REACT POWER INPUT: +00% </div>	<p>The input value should range between -60% and +60%, which varies with the standard.</p>

5.5.7.3 GRID POWER

Interface	Description
GRID PERCENT INPUT: 100%	The input value is power percent of grid.

5.5.7.4 DISCHARGE POWER

Interface	Description
DISC PERCENT INPUT: 100%	The input value is power percent of battery discharge.

5.5.7.5 PV POWER

Interface	Description
PV PERCENT INPUT: 100%	The input value is power percent of PV.

5.5.7.6 VAC-MIN

Interface	Description
GRID VOLT LOW INPUT: 150 UNIT: V	The input value of Grid low voltage. It effect when grid mode choose custom.

5.5.7.7 VAC-MAX

Interface	Description
GRID VOLT HIGH INPUT: 280 UNIT: V	The input value of Grid high voltage. It effect when grid mode choose custom.

5.5.7.8 FAC-MIN

Interface	Description
GRID FREQ LOW INPUT: 57.0 UNIT: Hz	The input value of Grid low frequency. It effect when grid mode choose custom.

5.5.7.9 FAC-MAX

Interface	Description
GRID FREQ HIGH INPUT: 63.0 UNIT: Hz	The input value of Grid high frequency. It effect when grid mode choose custom.

5.5.8.10 ACTIVE REF.

Interface	Description
ACTIVE Type 1.PWR-VOLT RES → 2.PWR-FREQ RES 3.PFC-VOLT RES 4.PFC-FREQ RES 5.Reserved1 6.Reserved2 7.Reserved3 8.Reserved4	This interface is used to select active reference. Press Up/Down button to move corresponding options; Press Enter button to enter the selected menu. Each menu have enable or disable, set it when you need. All default are enable.

5.5.8 485 Address

5.5.8.1 485 Address

Interface	Description
485 ADDRESS INPUT: 1	This interface is used to select 485 address.

5.5.9 485 BAUD RATE

5.5.9.1 BAUD RATE

Interface	Description
<pre>SELECT → 1.2400 bps 2.4800 bps 3.9600 bps</pre>	This interface is used to select 485 baud rate.

5.5.10 LANGUAGE

5.5.10.1 LANGUAGE

Interface	Description
<pre>LANGUAGE 1.Chinese → 2.English</pre>	This interface is used to select language.

5.5.11 BACKLIGHT

5.5.11.1 BACKLIGHT

Interface	Description
<pre>LIGHT TIME INPUT: 20 UNIT: SEC</pre>	This interface is used to set light time.

5.5.12 DATE/TIME

5.5.12.1 DATE/TIME

Interface	Description
<pre>DATE/TIME DATE: 2021-12-25 TIME: 22:30:00 WEEK: Saturday</pre>	This interface is used to set date and time.

5.5.13 CLEAR REC

5.5.13.1 Clear history

Interface	Description
<p>DEL REC → 1.CANCEL 2.CONFIRM</p>	This interface is used to clear operation history.

5.5.14 PASSWORD

5.5.14.1 PASSWORD

Interface	Description
<p>PASSWORD OLD: XXXXX NEW: XXXXX CONFIRM: XXXXX</p>	This interface is used to set password.

5.5.15 MAINTENANCE

5.5.15.1 MAINTENANCE

Interface	Description
<p>PASSWORD INPUT: XXXXX</p>	This interface is used to enter maintenance.

5.5.16 FCTRY RESET

5.5.16.1 FACTORY RESET

Interface	Description
<p>FACTORY RESET → 1.CANCEL 2.CONFIRM</p>	This interface is used to reset the inverter.

5.6 INQUIRE

5.6.1 INQUIRE

Interface	Description
INQUIRE → 1.INV MODULE 2.MODULE SN 3.FIRMWARE 4.RECORD 5.DIAGNOSE	Press Up/Down button to move corresponding options; Press Enter button to jump to the selected menu. Press ESC button to return to other interface.

5.6.1.1 INV MODULE

Interface	Description
MODEL 12K	This interface show inverter model..

5.6.2 MODULE SN

Interface	Description
S / N GUID: XXXXXXXX XXXXXXXXXXXXXXXX SN:FXXXXXXXXXXXXX	This interface show module SN.

5.6.3 FIRMWARE

Interface	Description
FIRMWARE ARM: V1.XX.XX DSP: V1.XX.XX	This interface show Software version.

5.6.4 RUNNING RECORDS

Interface	Description
<div style="border: 1px solid black; padding: 5px;"> REC(01) 02:Batdisconnect UP: 12-25 23:00 DOWN: </div>	This interface show running recodes.

5.6.5 DIAGNOSE

Interface	Description
<div style="border: 1px solid black; padding: 5px;"> DIAGNOSE 000000 000000 000000 000000 000000 000000 </div>	Factory internal use.

5.7 STATISTIC

5.7.1 STATISTIC

Interface	Description
<div style="border: 1px solid black; padding: 5px;"> STAT. → 1.TIME STAT. 2.CONNE.TIMES 3.PEAK POWER 4.E-TODAY 5.E-MONTH 6.E-YEAR 7.E-TOTAL </div>	This interface show inverter operation statistic. 1. Inverter operation and Grid-connection time statistic. 2. Inverter Grid-connection times statistic. 3. Displays power peak in history and for the day. 4. Displays statistic for the day (KWH). 5. Displays statistic for the month (KWH). 6. Displays statistic for the year (KWH). 7. Displays statistic of the inverter (KWH).

Note: 1. E-TODAY/MONTH/YEAR/TOTAL → INPUT → PV/GRID(Consume)/BATD(Battery discharge)

→ OUTPUT → BATC(Batterycharge)/GRID(Generation)/

CNSUM(Load consume)

2. If the inverter shut down before 24:00 on that day, and the day statistic will not be stored.

5.8 Autotest Fast

1. SETUP	press the Enter button and default password 00000
↓	
14. AUTO TEST	press the Enter button to start
Testing 59.S1...	
↓	Wait
Test59. S10K!	
↓	Wait
Testing 59.S2...	
↓	Wait
Test59. S20K!	
↓	Wait
Testing 27. S1...	
↓	Wait
Test27. S10K!	
↓	Wait
Testing 27. S2...	
↓	Wait
Test27. S20K!	
↓	Wait
Testing 81>S1...	
↓	Wait
Test81>S1 OK!	
↓	Wait
Testing 81>S2...	
↓	Wait
Test81>S2 OK!	
↓	Wait
Testing 81<S1...	
↓	Wait
Test81<S1 OK!	
↓	Wait
Testing 81<S2...	
↓	Wait
Test81<S2 OK!	
↓	Wait
Auto TestOK!	
↓	
59. S1:228V 902ms	
↑ ↓	Press the up/down button to page through the test results
59. S2:229V 204ms	

↑ ↓	Press the up/down button to page through the test results
27. S1:228V 408ms	
↑ ↓	Press the up/down button to page through the test results
27. S2:227V 205ms	
↑ ↓	Press the up/down button to page through the test results
81>. S1 49. 9Hz 103ms	
↑ ↓	Press the up/down button to page through the test results
81>. S2 49. 9Hz 107ms	
↑ ↓	Press the up/down button to page through the test results
81<. S1 50. 0Hz 105ms	
↑ ↓	Press the up/down button to page through the test results
81<. S2 50. 1Hz 107ms	

Object	Description
27.S1	Under voltage protection
27.S2	Under voltage protection
59.S1	Over voltage protection
59.S2	Over voltage protection
81<S1	Under frequency protection
81<S2	Under frequency protection
81>S1	Over frequency protection
81>S2	Over frequency protection

6. Fault diagnosis and solutions

The inverter is easy to maintain. When you encounter the following problems, please refer to the Solutions below, and contact the local distributor if the problem remains unsolved. The following table lists some of the basic problems that may occur during the actual operation as well as their corresponding basic solutions.

Fault diagnosis table

Content	Codes	Solutions
DischgOverCur	00	Battery discharge over current. (1) Nothing need to do, Wait one minute for the inverter to restart. (2) Check whether the load is in compliance with the specification. (3) Cut off all the power and shut down all the machines; disconnect the load and plug in to restart machines, then check
Over Load	01	The load power is greater than other power(PV,BAT). (1) Check whether the load is in compliance with the maximum power of the machine. (2) Cut off all the power and shut down all the machines; disconnect the load and plug in to restart machines, then check whether the load is short circuited if the fault has been eliminated. (3) Contact customer service if error warning continues.
BatDisconnect	02	Battery Disconnect. (Battery voltage not identified) (1) Check whether the battery is connected. (2) Check if battery wiring port is open circuited. (3) Contact customer service if error warning continues.
Bat Under Vol	03	Battery voltage low that normal range. (1) Checking System Settings, If so, power off and restart. (2) Check if the grid power down. If so, waiting for the grid power up, the inverter will automatically charge. (3) Contact customer service if error warning continues.
Bat Low capacity	04	Battery Low that setting capacity.(SOC<100%-DOD)
Bat Over Vol	05	The battery voltage is greater than the Inverter maximum voltage. (1) Checking System Settings, If so, power off and restart. (2) Contact customer service if error warning continues.
Gird low vol	06	Grid voltage is abnormal (1)Check if the grid is abnormal.
Grid over vol	07	(2) Restart the inverter and wait until it functions normally. (3) Contact customer service if error warning continues.

Grid low freq	08	Grid Frequency is abnormal. (1)Check if the grid is abnormal.
Grid overFreq	09	(2) Restart the inverter and wait until it functions normally. (3) Contact customer service if error warning continues.
gpci over	10	Inverter GFCI exceeds standard. (1) Check PV string for direct or indirect grounding phenomenon. (2) Check peripherals of machine for current leakage. (3) Contact the local inverter customer service if fault remains unremoved.
bus under vol	13	BUS voltage is lower than normal. (1) Check the input mode setting is correct. (2) Restart the inverter and wait until it functions normally. (3) Contact customer service if error warning continues.
bus over vol	14	BUS voltage is over maximum value.. (1) Check the input mode setting is correct. (2) Restart the inverter and wait until it functions normally.
Inv over cur	15	The inverter current exceeds the normal value. (1) Restart the inverter and wait until it functions normally.
Chg over cur	16	Battery charge current over than the Inverter maximum voltage. (1) Restart the inverter and wait until it functions normally.
Bus vol osc	17	Bus voltage instability. (1) Check the input and output mode setting is correct. (2) Restart the inverter and wait until it functions normally.
Inv under vol	18	INV voltage is abnormal (1)Check if the INV voltage is abnormal.
Inv over vol	19	(2) Restart the inverter and wait until it functions normally. (3) Contact customer service if error warning continues.
InvFreqAbnor	20	INV frequency is abnormal (1)Check if the INV frequency is abnormal. (2) Restart the inverter and wait until it functions normally. (3) Contact customer service if error warning continues.
igbt temp high	21	The inverter temperature is higher than the allowed value (1) Cut off all the power of the machine and wait one hour, then turn on the power of the machine.
bat over temp	23	Battery temperature is higher than the allowed value. (1) Disconnect the battery and reconnect it after an hour.
bat UnderTemp	24	Battery temperature is low than the allowed value. (1) Check the ambient temperature near the battery to see if it meets the specifications.
BMS comm.fail	27	Communication between lithium battery and inverter is abnormal. (1) Check the cable, crystal, Line sequence. (2) Checking the Battery switch.

Fan fail	28	Fan fail (1) Check whether the Inverter temperature is abnormal. (2) Check whether the fans run properly.(If you can see it)
Grid Phase err	30	The grid fault phase. (1) Check power grid wiring
Arc Fault	31	PV Arc Fault (1) Check Photovoltaic panels, PV wire. (2) Contact customer service if error warning continues.
bus soft fail	32	(1) Restart the inverter and wait until it functions normally. (2) Contact customer service if error warning continues.
inv soft fail	33	
bus short	34	
inv short	35	
fan fault	36	Fan fault. (1) Check whether the Inverter temperature is abnormal. (2) Check whether the fans run properly.(If you can see it)
PV iso low	37	(1) Check if the PE line is connected to the inverter and is connected to the ground. (2)Contact customer service if error warning continues.
Bus Relay Fault	38	(1) Restart the inverter and wait until it functions normally. (2) Contact customer service if error warning continues.
Grid Relay Fault	39	
EPS rly fault	40	
Gfci fault	41	
Selftest fail	44	
System fault	45	
Current DCover	46	
Voltage DCover	47	

Note: If an error occurs that is not listed in the table, Please Contact customer service.